

Functorial Semantics for Partial Theories

IVAN DI LIBERTI, Institute of Mathematics, Czech Academy of Sciences, Czech Republic
 FOSCO LOREGIAN, CHAD NESTER, and PAWEŁ SOBOCIŃSKI, Tallinn University of Technology, Estonia

We provide a Lawvere-style definition for partial theories, extending the classical notion of equational theory by allowing partially defined operations. As in the classical case, our definition is syntactic: we use an appropriate class of string diagrams as terms. This allows for equational reasoning about the class of models defined by a partial theory. We demonstrate the expressivity of such equational theories by considering a number of examples, including partial combinatory algebras and cartesian closed categories. Moreover, despite the increase in expressivity of the syntax we retain a well-behaved notion of semantics: we show that our categories of models are precisely locally finitely presentable categories, and that free models exist.

CCS Concepts: • **Theory of computation** → **Categorical semantics**.

Additional Key Words and Phrases: Lawvere theory, categories of partial maps, syntax, semantics, variety theorem.

ACM Reference Format:

Ivan Di Liberti, Fosco Loregian, Chad Nester, and Paweł Sobociński. 2021. Functorial Semantics for Partial Theories. *Proc. ACM Program. Lang.* 5, POPL, Article 57 (January 2021), 28 pages. <https://doi.org/10.1145/3434338>

1 INTRODUCTION

Mathematicians interested in, say, the theory of monoids or the theory of groups work in an axiomatic setting, asserting the presence of a collection of n -ary *operations* on an ambient set A — i.e. (total) functions $A^n \rightarrow A$ for some $n : \mathbb{N}$ — that satisfy a number of axioms. This data can be packaged up into an *equational theory*: a pair (Σ, E) where Σ is the *signature*, consisting of *operation symbols*, each with a specified arity, and E is a collection of *equations* — i.e. pairs of *terms* built up from the signature Σ and auxiliary variables — that provide the axioms. An ambient equational theory is thus the bread and butter of an algebraist, that together with the principles of equational reasoning provides the basic calculus of mathematical investigation into the structure of interest.

Birkhoff [Birkhoff 1935] discovered that a substantial amount of mathematics can be done at the level of generality of an equational theory. Given an equational theory (Σ, E) , a *model* is a set together with an interpretation of the function symbols Σ that satisfies the equations E . A monoid is nothing but a model of the equational theory of monoids, a group is a model of the equational theory of groups, and so on. The semantics of an equational theory, i.e. its class of models, is called a *variety*. Birkhoff showed that certain results (e.g. the so-called isomorphism theorems, existence of free models) can be derived uniformly for generic varieties, independent of the equational theory

Authors' addresses: Ivan Di Liberti, diliberti.math@gmail.com, Institute of Mathematics, Czech Academy of Sciences, Prague, Czech Republic; Fosco Loregian, fosco.loregian@taltech.ee; Chad Nester, chad.nester@taltech.ee; Paweł Sobociński, pawel.sobocinski@taltech.ee, Department of Software Science, Tallinn University of Technology, Tallinn, Estonia.



This work is licensed under a Creative Commons Attribution 4.0 International License.

© 2021 Copyright held by the owner/author(s).

2475-1421/2021/1-ART57

<https://doi.org/10.1145/3434338>

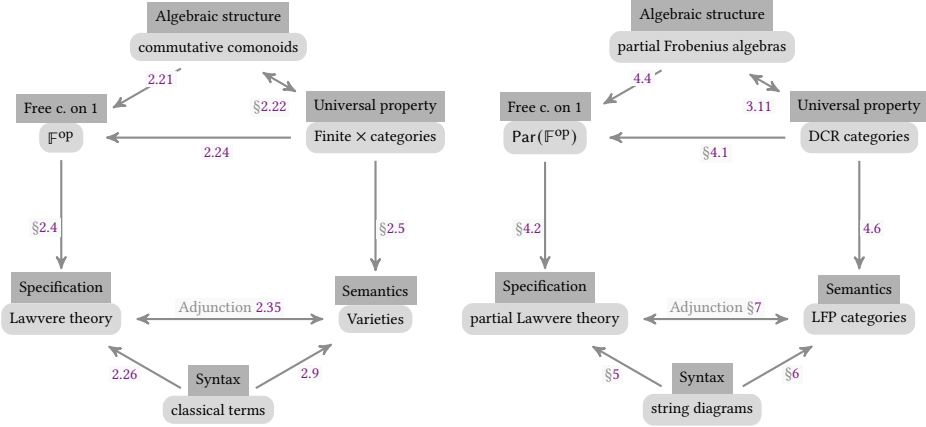

Fig. 1. Elements of classical functorial semantics on the left, and our contribution on the right.

at hand. Most spectacularly, a class of sets-with-structure can be determined to be a variety through purely structural means; this is often referred to as Birkhoff’s Variety Theorem or the HSP Theorem.

The resulting field is known as *universal algebra*. Its mathematical objects of study are equational theories and varieties. Given its goal of uncovering methodological and technical similarities of a large swathe of contemporary algebra, universal algebra is in the intersection of mathematics and mathematical logic. It has influenced computer science, especially programming language theory, as a formal and generic treatment of syntax, terms, equational reasoning, etc.

Lawvere [Lawvere 1963], and the subsequent development of *categorical* universal algebra, addressed some of the perceived shortcomings of the classical account. It is well known that a single variety can have many different axiomatic presentations, and in this sense the choice of a particular presentation may seem ad hoc. The requirement that models be sets-with-structure is also restrictive, since algebraic structures appear in other mathematical contexts as well. A Lawvere theory is a category \mathcal{L} that serves as a *presentation-independent* way of capturing the specification of a variety. A central conceptual role is played by *cartesian categories*, i.e. categories with finite products. The free cartesian category on one object often appears in the very definition of a Lawvere theory – the “one object” here capturing single-sortedness. Finite products track arities and ensure that operations are total functions. Functorial semantics gives us the correct generalisation of varieties: a model is cartesian functor $\mathcal{L} \rightarrow \text{Set}$. This point of view is flexible (e.g. Set can be replaced with another cartesian category) and leads to a rich theory [Adámek et al. 2003; Hyland and Power 2007; Lawvere 1963], where the study of varieties and their specifications can take place at a high level of generality.

The beautiful abstract picture painted by Lawvere can be used to give a post-hoc explanation of the elements of *classical* equational theories. Every equational theory yields a Lawvere theory. Free equational theories, i.e. those where $E = \emptyset$, are Lawvere theories whose arrows can be concretely described as (tuples of) terms. Indeed, it is well-known that terms are closely connected to the universal property of products. The abstract mathematics, therefore, *explains* the structure of terms and *justifies* the use of ordinary equational reasoning. The elements of Lawvere’s approach to universal algebra are illustrated in the left side of Fig. 1.

In this paper we are concerned with *partial* algebraic structures, i.e. those where the operations are not, in general, defined on their whole domain. Partiality is important in mathematics: the very

notion of *category* itself is a partial algebraic structure, since only compatible pairs of arrows can be composed. Even more so, partiality is an essential property of computation, and partial functions play a role in many different parts of computer science, starting with initial forays into recursion theory at the birth of the subject, and being ever present in more recent developments, for example arising as an essential ingredient in the study of fixpoints [Bloom and Ésik 1993]. From the start it was clear that additional care is necessary for partial operations, the terms built up from them, and the associated principles of (partial) equational reasoning. An example is the principle of *Kleene equality*: using $s = t$ to assert that whenever one side is defined, so is the other, and they are equal, or the use of notation $-|_X$ to restrict the domain of definition of a function. In general, reasoning about partially defined terms can be quite subtle.

Our contribution is summarised on the right hand side of Fig. 1 and follows Lawvere’s approach closely. A key question that we address is what replaces the central notion of cartesian category. This turns out to be the notion of *discrete cartesian restriction* (DCR) category, which arose from research on the structure of partiality [Cockett et al. 2012]. Just as the free cartesian category on one object plays a central role in the definition of Lawvere theory, the free DCR category on one object plays a central role in the definition of *partial* Lawvere theory that we propose. In our development, the category of sets and partial functions Par replaces Set as the universe of models. Much of the richness of the classical picture is unchanged: e.g. we obtain free models just as in the classical setting. Moreover, we prove a variety theorem that characterises partial varieties as locally finitely presentable (LFP) categories.

Props [Lack 2004; Mac Lane 1965] and their associated *string diagrams*, play a crucial technical role. Props are a convenient categorical structure that capture generic *monoidal* theories. Monoidal theories differ from equational theories in that, roughly speaking, in that we are able to consider more general monoidal structures other than the cartesian one. String diagrams are the syntax of props, and they are a bona fide syntax not far removed from traditional terms. For example, they can be recursively defined and enjoy similar properties as free objects, e.g. the principle of structural induction. The connective tissue between the classical story and string diagrams is Fox’s Theorem [Fox 1976], which states that the structure of cartesian categories can be captured by the presence of local algebraic structure: a coherent and natural commutative comonoid structure on each object. This implies several things: (i) that classical terms can be seen as particular kinds of string diagrams, (ii) that classical equational reasoning can be seen as diagrammatic reasoning on these string diagrams and (iii) that the prop induced from the monoidal theory of commutative comonoids – well-known to coincide with \mathbb{F}^{op} , the opposite of the prop of finite sets and functions – is the free cartesian category on one object. The correspondence goes further: as shown in [Bonchi et al. 2018], Lawvere theories are particular kinds of monoidal theories.

We are able to identify the nature of the free DCR category on one object by proving a result similar to Fox’s Theorem, but for DCR categories instead of cartesian categories. Instead of commutative comonoids, we identify the algebraic structure of interest as *partial Frobenius algebras*. The free DCR category on one object is the prop induced from this monoidal theory, and it can be characterised as $\text{Par}(\mathbb{F}^{\text{op}})$: the prop of partial functions in \mathbb{F}^{op} . This informs our definition of partial Lawvere theory. Crucially, just as the mathematics of ordinary Lawvere theories serves as a post hoc justification for equational theories, we identify the precise class of string diagrams that serve as *partial terms*, which lets us define a *partial equational theory* in a familiar way as pair of signature and equations. We give several examples, from partial commutative monoids, to several examples important in computer science, notably the theory of partial combinatory algebras [Bethke 1988], the theory of pairing functions, and the theory of cartesian closed categories.

To summarise, the original contributions of this paper are:

- A “Fox theorem” for DCR categories, which uses the notion of *partial Frobenius algebra* and leads to the characterisation of the free DCR category on one object as $\text{Par}(\mathbb{F}^{\text{op}})$;
- The definitions of partial Lawvere theory and partial equational theory, which use string diagrammatic syntax informed by the aforementioned Fox theorem;
- The coupling of these notions into a comprehensive framework for partial algebraic theories, analogous to the work of Lawvere on classical algebraic theories, as illustrated in Fig. 1;
- The existence of free models, and—more generally—a variety theorem, building on known results about DCR categories, and the Gabriel-Ulmer duality.

Related work. There are a number of formalisms in the literature that aim at providing a rigorous way of specifying partial algebraic structure. Freyd’s *essentially algebraic theories* [Freyd 1972] were introduced informally, but were subsequently formalised and generalised in various ways [Adamek and Rosický 1994; Adámek et al. 2011; Palmgren and Vickers 2007]. A different, but equally expressive approach is via *finite limit sketches* [Adamek and Rosický 1994]. Nevertheless, none of these approaches can claim to have the foundational status of classical equational theories - e.g. they do not, per se, provide a canonical notion of syntax to replace classical terms, nor a calculus for (partial) equational reasoning about the categories of models they define. Tout court, none of them can claim to be *equational*. Interestingly, the semantic landscape (i.e. the corresponding notion of *partial variety*) is better understood than the syntax. The class of models of essentially algebraic theories and finite limit sketches are closely related to Gabriel-Ulmer duality [Centazzo 2004], which asserts a contravariant (bi)equivalence between the category of categories with finite limits and the category of locally finitely presentable (LFP) categories.

Partial Frobenius algebras, which arise in our characterisation of DCR categories, are special/separable Frobenius algebras without units. The version *with* units was originally studied in [Carboni and Walters 1987], is deeply connected to the relational algebra [Freyd and Scedrov 1990], characterises 2-dimensional TQFTs [Kock 2003], and has been used extensively in categorical approaches to the study of quantum information and quantum computing, such as the ZX calculus [Coecke and Duncan 2008]. In a similar way to the use of partial Frobenius algebras in this paper, they are used in the recently proposed *Frobenius theories* [Bonchi et al. 2017], which are algebraic theories that take their models in the category of relations Rel , and are guided by the structure of cartesian bicategories of relations [Carboni and Walters 1987].

Restriction categories were introduced in [Cockett and Lack 2002] as a general framework for reasoning about categories of partial maps. Cartesian restriction (CR) categories are those with a certain sort of formal finite product structure – restriction products – introduced in [Cockett and Lack 2007]. Notably, the p -categories of [Robinson and Rosolini 1988] arise as restriction categories with restriction products. Discrete cartesian restriction (DCR) categories – named for a similarity to categories of discrete topological spaces – arise in [Cockett et al. 2012] as the restriction categories with finite *latent* limits – again a sort of formal limit. DCR categories are closely connected to the *discrete inverse categories* considered in [Giles 2014] which are presentable in terms of *semi-Frobenius* algebras, being those special/separable commutative Frobenius algebras with neither a unit *nor* a counit.

Structure of the paper. In $S2$ we lay the foundations by recalling the basic concepts of universal algebra, props and string diagrams, Fox’s theorem, and functorial semantics. In $S3$, after recalling the basics of restriction category theory, we prove Theorem 3.6, which is to DCR categories what Fox’s theorem is to cartesian categories. In $S4$ we propose our original definitions: partial Lawvere theories and their varieties. Next, $S5$ is devoted to the associated notion of partial equational theory, and several examples, continued in $S6$ with multi-sorted examples. Our variety theorem is in $S7$ where we also treat other semantic aspects, e.g. the existence of free models.

2 BACKGROUND MATERIAL

2.1 Overview of Classical Universal Algebra

Universal algebra is the study of *equational theories* and of their semantics, *varieties*. In this section we recall the basic concepts and definitions.

Definition 2.1. A *signature* is a pair (Σ, α) where Σ is a set and α a function $\Sigma \rightarrow \mathbb{N}$ that assigns to every element $t : \Sigma$ a natural number $\alpha(t) : \mathbb{N}$ called the *arity* of the *function symbol* t .

Notation 2.2. The arity “slices” the set Σ of function symbols. The slice $\Sigma_n \subseteq \Sigma$ contains operations of arity n , and $t : \Sigma_n$ is a synonym for “ t is a n -ary operation”. We will sometimes write t_n for a generic element of Σ_n . We shall refer to the signature as just Σ if the arity function is understood from the context. For example the signature Σ_M of *monoids* is $\{m, e\}$, with $\alpha(m) = 2$ and $\alpha(e) = 0$.

Definition 2.3. An Σ -*algebra* is a pair $(A, \llbracket - \rrbracket_A)$ where A is a set and $\llbracket - \rrbracket_A$ is a function sending function symbols $t : \Sigma_n$ to functions $\llbracket t \rrbracket_A : A^n \rightarrow A$. The function $\llbracket t \rrbracket_A$ is called the n -ary operation on A associated to the function symbol $t : \Sigma_n$. We refer to A as the *carrier* of the Σ -algebra. A Σ -algebra homomorphism from $(A, \llbracket - \rrbracket_A)$ to $(B, \llbracket - \rrbracket_B)$ is a function $f : A \rightarrow B$ that respects the Σ structure: i.e. for every $n \in \mathbb{N}$ and $t_n : \Sigma_n$, the diagram on the right commutes:

$$\begin{array}{ccc} A^n & \xrightarrow{f^n} & B^n \\ \llbracket t_n \rrbracket_A \downarrow & & \downarrow \llbracket t_n \rrbracket_B \\ A & \xrightarrow{f} & B \end{array}$$

Remark 2.4. Σ -algebras and their homomorphisms define a category \mathcal{V}_Σ .

Of course, an algebraic structure isn’t just about operations, but also about *properties* enjoyed by those operations. To express this we first need the notion of *term*. Fixing a signature Σ , we recall the usual recursive construction of the set of terms T_Σ^V , for some set of variables V :

$$T_\Sigma^V ::= V \mid t_0 \mid t_1(T_\Sigma^V) \mid t_2(T_\Sigma^V, T_\Sigma^V) \mid \dots \mid t_n(T_\Sigma^V, \dots, T_\Sigma^V) \mid \dots$$

In the above, each t_i ranges over the function symbols in Σ_i . For any V , T_Σ^V carries a canonical Σ -algebra structure: $\llbracket t \rrbracket(t_1, t_2, \dots, t_{n_t}) \stackrel{\text{def}}{=} t(t_1, t_2, \dots, t_{n_t})$. We call this the term Σ -algebra over V .

Observation 2.5. The term Σ -algebra T_Σ^V enjoys a universal property: given a Σ -algebra $(A, \llbracket - \rrbracket_A)$ and function $v : V \rightarrow A$, there is a unique extension to a homomorphism of algebras $\bar{v} : T_\Sigma^V \rightarrow A$. This is just the induction principle associated to the recursive definition of terms.

Definition 2.6 (Σ -*equation*). Fixing V , a Σ -*equation* is a pair $(s, t) \in T_\Sigma^V \times T_\Sigma^V$; we usually write ‘ $s = t$ ’. A Σ -equation $s = t$ *holds* in Σ -algebra $(A, \llbracket - \rrbracket_A)$ if for all $v : V \rightarrow A$ we have $\bar{v}(s) = \bar{v}(t)$ in A .

Given the signature of monoids, we can express properties such as associativity: $m(x, m(y, z)) = m(m(x, y), z)$; or commutativity: $m(x, y) = m(y, x)$; etc. The idea is that a set of Σ -equations *constrains* the choice of algebras $(A, \llbracket - \rrbracket_A)$ to those where every equation holds.

Definition 2.7 (*Equational Theory and Variety*). A pair (Σ, E) where Σ is a signature and E a set of Σ -equations is called an *equational theory*. A *model* of (Σ, E) is a Σ -algebra where every $e : E$ holds. The class of models for an equational theory is called a *variety*.

Example 2.8. The equational theory of commutative monoids is

$$(\{m, e\}, \{m(m(x, y), z) = m(x, m(y, z)), m(x, y) = m(y, x), m(e, x) = x\}).$$

The corresponding variety is the class of commutative monoids.

Some of the most famous results of universal algebra characterise varieties. For example:

Theorem 2.9 (*Birkhoff* [Birkhoff 1935]). A class of Σ -algebras is a variety if and only if it is closed under homomorphic images, subalgebras and products.

2.2 Props and Monoidal Theories

Our development is informed by the differences between the algebraic structure of total functions and partial functions. Given the focus on algebra, the notion of prop is useful as a categorical gadget on which to hang an algebraic structure. Moreover, the associated notion of string diagram will lead us to a syntax with which to express partial equational theories by appropriately generalising classical terms. Here we recall the basic definitions of props [Lack 2004], string diagrams and some of the algebraic structures that are prominent in subsequent sections.

Definition 2.10 (Prop [Mac Lane 1965, Ch. 5]). A *prop* is a symmetric strict monoidal category with set of objects the natural numbers \mathbb{N} , where the monoidal product on objects is addition: $m \otimes n := m + n$. A *homomorphism of props* is an identity-on-objects symmetric strict monoidal functor.

Example 2.11. An important example is the prop \mathbb{F} of finite ordinal numbers. In the following, $[m] \stackrel{\text{def}}{=} \{1, 2, \dots, m\}$. The \mathbb{F} -arrows $m \rightarrow n$ are all functions $[m] \rightarrow [n]$: composition is function composition, and the monoidal product is “disjoint union”; i.e. for $f_1: m_1 \rightarrow n_1$ and $f_2: m_2 \rightarrow n_2$,

$$(f_1 \otimes f_2)(i): m_1 + m_2 \rightarrow n_1 + n_2 \stackrel{\text{def}}{=} \begin{cases} f_1(i) & \text{if } i \leq m_1 \\ f_2(i - m_1) + n_1 & \text{otherwise.} \end{cases}$$

Free props generated from some signature of operations are of particular importance.

Definition 2.12 (Monoidal signature). A monoidal signature Γ is a collection of *generators* $\gamma: \Gamma$, each with an arity $ar(\gamma): \mathbb{N}$ and coarity $coar(\gamma): \mathbb{N}$.

Concrete terms can be given a BNF description, as follows:

$$c ::= \gamma \in \Gamma \mid \boxed{} \mid \text{---} \mid \text{---} \times \text{---} \mid c \otimes c \mid c \wp c \quad (1)$$

Arities and coarities are not handled in the BNF but with an associated sorting discipline, shown below. We only consider terms that have a sort, which is unique if it exists.

$$\frac{}{\gamma: (ar(\gamma), coar(\gamma))} \quad \frac{}{\boxed{}: (0, 0)} \quad \frac{}{\text{---}: (1, 1)} \quad \frac{}{\text{---} \times \text{---}: (2, 2)} \quad \frac{c: (n, z) \quad d: (z, m)}{c \wp d: (n, m)} \quad \frac{c: (n, m) \quad d: (r, z)}{c \otimes d: (n+r, m+z)}$$

The idea is that the sort $c: (m, n)$ counts the number of “dangling wires” of each term. Every sortable term generated from (1) has a diagrammatic representation. The convention for $\gamma: \Gamma$ is to draw it as a box with $ar(\gamma)$ “dangling wires” on the left and $coar(\gamma)$ on the right:

$$ar(\gamma) \left\{ \begin{array}{c} \boxed{} \\ \vdots \\ \boxed{} \end{array} \right\} coar(\gamma)$$

The conventions for the (1) operations are: $c \wp c'$ is drawn $\begin{array}{c} \boxed{c} \\ \vdots \\ \boxed{c'} \end{array}$ and $c \otimes c'$ is drawn $\begin{array}{c} \boxed{c} \\ \vdots \\ \boxed{c'} \end{array}$.

The sorting discipline ensures that the convention for \wp makes sense.

Example 2.13. Consider the following signature, where the (co)arities are apparent from the

$$\Gamma \stackrel{\text{def}}{=} \left\{ \begin{array}{c} \text{---} \\ \text{---} \end{array} \right\}, \left\{ \bullet \leftarrow \text{---} \right\} \quad (\text{CMG})$$

glyphs. The term $(\text{⌈} \text{---} \otimes (\text{---} \otimes \bullet)) ; ((\text{⌈} \text{---} \otimes \text{---}) ; \text{X})$ has sort $(3, 2)$ and diagram:

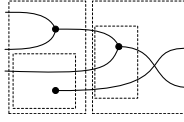

where the “dotted line” boxes serve the role of parentheses.

Terms of (1) are quotiented by the laws of symmetric strict monoidal categories. We do not go into the details here, but these are closely connected with the diagrammatic conventions. Indeed, they allow us to discard the “dotted line” boxes and focus *only* on the connectivity between the generators. For example the following two diagrams are in the same equivalence class of terms:

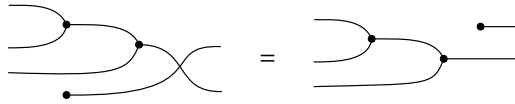

We refer to equivalence classes $[c] : m \rightarrow n$ as *string diagrams*.

Definition 2.14. The free prop \mathbb{X}_Γ on Γ has as arrows $m \rightarrow n$ string diagrams $[c] : (m, n)$.

String diagrams can be used to specify additional equations that specify algebraic structure.

Definition 2.15 (Monoidal theory [Lack 2004]). For a monoidal signature Γ , a Γ -equation is a pair $([c], [d])$ of equally-sorted string diagrams; we usually write ‘ $[c] = [d]$ ’. A *monoidal theory* is a pair (Γ, F) where F is a set of Γ -equations.

Given a monoidal theory (Γ, F) , the induced prop $\mathbb{X}_{(\Gamma, F)}$ can be obtained by taking a coequaliser in Cat . It can alternatively be given an explicit description as follows: as arrows $[m] \rightarrow [n]$ it has arrows of \mathbb{X}_Γ quotiented by the smallest congruence containing F .

Example 2.16. Consider the signature **(CMG)** and the following set of equations:

$$E \stackrel{\text{def}}{=} \left\{ \begin{array}{l} \text{⌈---} \bullet = \text{---} \text{⌈---} \bullet, \quad \text{X} \bullet = \text{⌈---} \bullet, \quad \bullet \text{---} = \text{---} \end{array} \right\}. \quad (\text{CM})$$

The resulting prop **CM** is the prop of *commutative monoids*. The equations, from left to right, express associativity, commutativity and unitality.

Remark 2.17. String diagrams in $\mathbb{X}_{(\Gamma, F)}$ are amenable to equational reasoning, often referred to as *diagrammatic reasoning* in this context: if $([c], [d]) \in F$ then substituting c for d inside any context is sound. For example in **CM** the set of equations contains only one of the unit laws. The other may be derived:

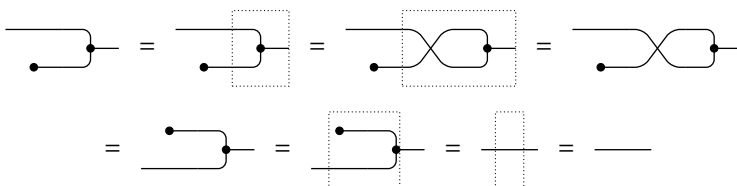

We typically omit the “dotted line” boxes in such chains of reasoning.

Interestingly, **CM** can be seen as the algebraic characterisation of \mathbb{F} .

Observation 2.18 ([Lack 2004]). As props, $\mathbb{F} \cong \mathbb{CM}$.

Remark 2.19. In fact, arrows of \mathbb{CM} can be intuitively understood as “pictures of functions”. For example, the function $f : 2 \rightarrow 2$ where $f(1) = f(2) = 1$ is drawn 

Example 2.20. The theory of commutative *comonoids* plays an important role for us. The data is:

$$\begin{array}{ccc}
 \begin{array}{c} \text{---} \\ | \\ \text{---} \end{array} & = & \begin{array}{c} \text{---} \\ | \\ \text{---} \end{array} \\
 \begin{array}{c} \text{---} \\ | \\ \text{---} \end{array} & = & \begin{array}{c} \text{---} \\ | \\ \text{---} \end{array} \\
 \begin{array}{c} \text{---} \\ | \\ \text{---} \end{array} & = & \begin{array}{c} \text{---} \\ | \\ \text{---} \end{array} \\
 \end{array} \quad \text{(CCMG)}$$

$$\begin{array}{ccc}
 \begin{array}{c} \text{---} \\ | \\ \text{---} \end{array} & = & \begin{array}{c} \text{---} \\ | \\ \text{---} \end{array} \\
 \begin{array}{c} \text{---} \\ | \\ \text{---} \end{array} & = & \begin{array}{c} \text{---} \\ | \\ \text{---} \end{array} \\
 \begin{array}{c} \text{---} \\ | \\ \text{---} \end{array} & = & \begin{array}{c} \text{---} \\ | \\ \text{---} \end{array} \\
 \end{array} \quad \text{(CCM)}$$

Let \mathbb{CC} be the prop induced from the monoidal theory ((CCMG),(CCM)).



Given that (CCMG) and (CCM) are mirrored (CMG) and (CM), Observation 2.18 gives:

Observation 2.21. As props, $\mathbb{F}^{\text{op}} \cong \mathbb{CC}$.

While we have specialised our discussion of string diagrams as the syntax of props, it is well-known that they can be used as a sound calculus in any symmetric (strict) monoidal category. Roughly speaking, objects are represented by wires, and morphisms by boxes.

2.3 Fox’s Theorem

Equational and monoidal theories are linked by Fox’s theorem ([Fox 1976]), recalled here – this will be explained in S2.6. *Cartesian* categories are categories with finite products, and *cartesian functors* preserve them. Fox showed that cartesian categories are exactly those that have a certain algebraic structure.

A commutative comonoid on an object X of a symmetric monoidal category \mathbb{X} is a triple $(X, \delta_X, \varepsilon_X)$ s.t. $\delta_X : X \rightarrow X \otimes X$ and $\varepsilon_X : X \rightarrow I$, depicted as  and  respectively, and these satisfy (CCM). If all objects are so equipped, then the structures are *coherent* if for all objects X, Y :

$$\begin{array}{ccc}
 \begin{array}{c} X \otimes Y \\ | \\ \text{---} \\ | \\ X \otimes Y \end{array} & = & \begin{array}{c} Y \\ | \\ \text{---} \\ | \\ X \end{array} \\
 \begin{array}{c} X \otimes Y \\ | \\ \text{---} \\ | \\ X \otimes Y \end{array} & = & \begin{array}{c} Y \\ | \\ \text{---} \\ | \\ X \end{array} \\
 \begin{array}{c} X \otimes Y \\ | \\ \text{---} \\ | \\ X \otimes Y \end{array} & = & \begin{array}{c} Y \\ | \\ \text{---} \\ | \\ X \end{array} \\
 \end{array} \quad \text{(coherent)}$$

Further, we say that the δ and ε are *natural* if for any arrow $f : X \rightarrow Y$ of \mathbb{X} , we have:

$$\begin{array}{ccc}
 \begin{array}{c} X \\ | \\ \text{---} \\ | \\ Y \end{array} & = & \begin{array}{c} X \\ | \\ \text{---} \\ | \\ Y \end{array} \\
 \begin{array}{c} X \\ | \\ \text{---} \\ | \\ Y \end{array} & = & \begin{array}{c} X \\ | \\ \text{---} \\ | \\ Y \end{array} \\
 \begin{array}{c} X \\ | \\ \text{---} \\ | \\ Y \end{array} & = & \begin{array}{c} X \\ | \\ \text{---} \\ | \\ Y \end{array} \\
 \end{array} \quad \text{(natural)}$$

Theorem 2.22 ([Fox 1976]). A cartesian category is the same thing as a symmetric monoidal category where every object is equipped with a (coherent) and (natural) commutative comonoid structure.

In light of Observation 2.21, we know that a commutative comonoid structure on X is equivalently a cartesian functor $\mathcal{X} : \mathbb{F}^{\text{op}} \rightarrow \mathbb{X}$ where $\mathcal{X}[1] = X$. The action of \mathcal{X} on objects is determined by its action on 1, and the generators give arrows $\mathcal{X}(\text{---}) = \delta_X : X \rightarrow X \otimes X$ and $\mathcal{X}(x \text{---}) = \varepsilon_X : X \rightarrow I$ of \mathbb{X} which satisfy (CCM). Thus we may specialize Theorem 2.22, to props as follows:

Corollary 2.23. A prop \mathbb{X} is cartesian (with categorical product the monoidal product) if and only if there is a homomorphism of props $\mathbb{F}^{\text{op}} \rightarrow \mathbb{X}$ and the picked out comonoid structure is (**natural**).

It is easy to show that a coherent and natural commutative comonoid structure, if it exists, is unique. An easy consequence of Theorem 2.22 is that a cartesian functor is precisely a symmetric monoidal functor that preserves the comonoid structure. This, combined with Corollary 2.23, gives:

Proposition 2.24. The prop \mathbb{F}^{op} is the free cartesian category on a single object.

2.4 Lawvere Theories

We recall Lawvere’s approach [Lawvere 1963] of *functorial semantics* of algebraic theories in the rest of the section. Lawvere’s approach is centered on the theory of cartesian categories.

Definition 2.25 (Lawvere theory). A *Lawvere theory* is a cartesian prop. A morphism of Lawvere theories is a cartesian prop homomorphism. Lawvere theories and homomorphisms define the category Law .

Finite products do two jobs: they keep track of arities of operations, and—less obviously—they ensure the *totality* and *single-valuedness* of the interpretation of function symbols in any model.

Free categories with products play a leading role. Recall from Proposition 2.24 that \mathbb{F}^{op} is the free category with products on one object. Spelled out, a Lawvere theory is a cartesian category \mathcal{L} and an identity-on-objects cartesian functor $\mathbb{F}^{\text{op}} \rightarrow \mathcal{L}$. A morphism of Lawvere theories is a functor $h : \mathcal{L} \rightarrow \mathcal{M}$ s.t. the following triangle commutes:

$$\begin{array}{ccc} & \mathbb{F}^{\text{op}} & \\ p \swarrow & & \searrow q \\ \mathcal{L} & \xrightarrow{h} & \mathcal{M} \end{array}$$

Remark 2.26. Every equational theory gives rise to a Lawvere theory. For the case of no equations (Σ, \emptyset) , this Lawvere theory \mathcal{L}_Σ is the free category with products on Σ . It also has a simple, concrete description that uses Σ -terms. An arrow $m \rightarrow n$ is an n -tuple

$$(t_1, t_2, \dots, t_n) \quad \text{where each } t_i : T_\Sigma^{[m]} \quad (2)$$

i.e. where each term in the tuple may use formal variables from the set $\{1, \dots, m\}$. Composition of $(s_1, \dots, s_k) : m \rightarrow k$ with $(t_1, \dots, t_n) : k \rightarrow n$ is via substitution:

$$(t_1[s_1/1, \dots, s_k/k], \dots, t_n[s_1/1, \dots, s_k/k]) : m \rightarrow n.$$

Given a set of equations E , ordering the variables in each $s = t : E$ induces pairs of arrows $s, t : m \rightarrow 1$ (where m is the number of variables appearing in s and t). Then $\mathcal{L}_{(\Sigma, E)}$ is obtained by “equating” s and t —this can be computed via a coequaliser, or directly as in (2) where terms are taken modulo the smallest congruence containing the required equations. We omit the details.

The Lawvere theory induced from the empty equational theory (\emptyset, \emptyset) is \mathbb{F}^{op} .

2.5 Semantics For Algebraic Theories

Here we recall some of the basic elements of functorial semantics.

Definition 2.27 (Model of a Lawvere theory). A *model* for a Lawvere theory \mathcal{L} is a cartesian functor $L : \mathcal{L} \rightarrow \text{Set}$. A model homomorphism $L \rightarrow L'$ is a natural transformation $\alpha : L \Rightarrow L'$. This defines the category of models $\text{Mod}_{\mathcal{L}}$ of a Lawvere theory \mathcal{L} .

Remark 2.28. There are forgetful functors $U : \text{Mod}_{\mathcal{L}} \rightarrow \text{Set}$, given by evaluating on the terminal object $F \mapsto F(1)$. Intuitively, U forgets the algebraic structure, returning the underlying carrier set.

Definition 2.27 is compatible with its classical counterpart: the data required to give a model of (Σ, E) , in the sense of Definition 2.7, is precisely that required to give a functor $\mathcal{L}_{(\Sigma, E)} \rightarrow \text{Set}$. The functorial approach lends itself to generalisations: e.g. replacing Set with another cartesian category. Moreover, it allows for further structural analysis.

Observation 2.29. $\text{Mod}_{\mathcal{L}}$ is closed under limits computed in the category of all functors $[\mathcal{L}, \text{Set}]$, because limits commute with limits. For a similar reason it is closed under sifted colimits. Thus the inclusion $\text{Mod}_{\mathcal{L}} \hookrightarrow [\mathcal{L}, \text{Set}]$ creates limits and sifted colimits¹.

Remark 2.30 (Multi-sorted, unsorted). The codomain of $U : \text{Mod}_{\mathcal{L}} \rightarrow \text{Set}$ betrays that our presentation is *single sorted*. Indeed when \mathcal{L} is S -sorted we obtain a functor $U : \text{Mod}_{\mathcal{L}} \rightarrow [S, \text{Set}]$. Historically, syntactic aspects are single sorted, while categorical variety theorems are most crisp in the *unsorted* case. It is thus worthwhile to focus on these concepts in more detail.

An S -sorted Lawvere theory is a cartesian S -coloured prop. Spelled out, it is an identity-on-objects cartesian functor $\mathbb{F}(S) \rightarrow \mathcal{L}$, where $\mathbb{F}(S)$ is the free cartesian category on S .

An *unsorted* Lawvere theory is simply a (small) category with products.

In the remainder of this section we focus on the unsorted version, because the treatment is notationally and technically simplified. Nevertheless, much of the following is sort-agnostic.

Observation 2.31. A theory morphism $h : \mathcal{L} \rightarrow \mathcal{L}'$ induces a (contravariant) functor

$$\text{Mod}_h : \text{Mod}_{\mathcal{L}'} \rightarrow \text{Mod}_{\mathcal{L}}$$

taking $F : \mathcal{L}' \rightarrow \text{Set}$ to $F \cdot h : \mathcal{L} \rightarrow \text{Set}$. The functor Mod_h always admits a left adjoint: Mod_h preserves limits and sifted colimits because they are computed in the underlying functor category. The special adjoint functor theorem can now be used to obtain a left adjoint $L_h : \text{Mod}_{\mathcal{L}} \rightarrow \text{Mod}_{\mathcal{L}'}$.

Example 2.32. For intuition, we consider a concrete example. Consider the inclusion i of the theory of monoids in commutative monoids. Then Mod_i is the functor that “forgets” commutativity. Its left adjoint takes a monoid and “forces” commutativity by quotienting the underlying carrier set.

Observation 2.33. Lawvere theories have free models. Let $p : \mathbb{F}^{\text{op}} \rightarrow \mathcal{L}$ be a Lawvere theory. Observation 2.31 gives an adjunction

$$F : \text{Mod}_{\mathbb{F}^{\text{op}}} \rightleftarrows \text{Mod}_{\mathcal{L}} : \text{Mod}_p.$$

Then Mod_p coincides with the forgetful functor of Remark 2.28. The left adjoint F gives free objects.

Because of Observation 2.31, it is natural to take adjunctions as *the* notion of variety morphism. Below, by *unsorted-variety* we mean a category equivalent to $\text{Mod}_{\mathcal{L}}$ for \mathcal{L} with finite products.

Definition 2.34. Let \mathcal{V}, \mathcal{W} be two (unsorted) varieties; a *morphism of varieties* is a functor $R : \mathcal{V} \rightarrow \mathcal{W}$ satisfying the following:

- MV1) R admits a left adjoint $L : \mathcal{W} \rightarrow \mathcal{V}$;
- MV2) R commutes with sifted colimits.

Given that adjunctions compose, this data yields a category Var .

Let Prod be the 2-category whose objects are small cartesian categories, morphisms are cartesian functors and 2-cells are natural transformations. Then Observation 2.31 boils down to defining a 2-functor $\text{Mod} : \text{Prod}^{\text{op}} \rightarrow \text{Var}$. The following captures the relationship between Law and Var .

¹Sifted \mathcal{J} -indexed colimits satisfy the following property: given a functor $E : I \times \mathcal{J} \rightarrow \text{Set}$, s.t. the category I is discrete (namely, it is just a set), the following isomorphism holds:

$$\text{colim}_{\mathcal{J}} \lim_I E(I, J) \cong \lim_I \text{colim}_{\mathcal{J}} E(I, J).$$

In other words, sifted colimits are those that commute with finite products in Set .

Theorem 2.35 ([Adámek et al. 2003, Theorem 4.1]). There exists a 2-adjunction whose unit is an equivalence:

$$\text{Th} : \text{Var} \rightleftarrows \text{Prod}^{\text{op}} : \text{Mod}$$

Remark 2.36. One obtains the S -sorted version of Theorem 2.35 by slicing on both sides over the free category with products on S . This is given in more detail for *partial* Lawvere theories in S7.2.

2.6 Equational Theories as Monoidal Theories

Given that Lawvere theories are cartesian props, Theorem 2.22 suggests how to consider them as monoidal theories. We recall the recipe from [Bonchi et al. 2018]: the idea is to characterise Σ -terms as certain string diagrams, and then—through this lens—turn any equational theory into a monoidal theory.

Recipe 2.37. Fix a signature Σ . A Σ -term $t : T_{\Sigma}^{[n]}$ is the same thing as a string diagram $n \rightarrow 1$ in the prop induced by the monoidal theory with

- generators $\Gamma \stackrel{\text{def}}{=} \Sigma + (\text{CCMG})$
- (CCM) together with equations that ensure naturality with respect to the comonoid structure. The latter can be easily added as two additional equations for each $\sigma : \Sigma$:

$$m \text{---} \overline{\sigma} \text{---} \left[\begin{array}{c} \text{---} \\ \text{---} \end{array} \right] = m \text{---} \left[\begin{array}{c} \overline{\sigma} \\ \overline{\sigma} \end{array} \right] \qquad m \text{---} \overline{\sigma} \text{---} \bullet = m \text{---} \bullet \qquad (\text{SN}\sigma)$$

The Lawvere theory induced by equational theory (Σ, E) can now be seen as the prop induced by the monoidal theory (Γ, F) where F is the set of equations obtained by translating the equations in E to string diagrams, together with (CCM), and (SN σ) for each $\sigma : \Sigma$.

It is important to build an intuition behind this translation. An obvious difference between terms and string diagrams is that the latter do not have named variables. The translation ensures that *wires* play the role of variables, and the comonoid structure plays the role of “variable management”. We illustrate this with an example below.

Example 2.38. The prop corresponding to the Lawvere theory induced by the equational theory of commutative monoids (Example 2.8) is the same as the prop of commutative bialgebra. For example, the term $m(m(x, x), y)$ in the theory of commutative monoids can be depicted as

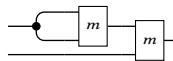

In the term we have considered, the variable x appears twice. In the corresponding diagram, the wire corresponding to x starts with a comultiplication that witnesses the “copying of x ”.

3 ALGEBRA OF PARTIAL MAPS

We have seen that finite products are central in classical universal algebra. It is therefore natural to begin our development of its partial analogue by identifying the corresponding universal property in the partial setting. We will see that this amounts to replacing the class of cartesian categories with the class of *discrete cartesian restriction categories* (DCR categories) [Cockett et al. 2012]. Next, we characterise DCR categories in terms of algebraic structure, analogous to Theorem 2.22 for cartesian categories.

3.1 Partial Functions

The starting point of our journey is the (2-)category Par of sets and partial functions. Just as Set was the semantic universe for ordinary equational theories, Par is the semantic universe for partial equational theories. We first recall an elementary, set theoretic presentation:

Definition 3.1. Par has sets as objects and *partial functions* $f: X \rightarrow Y$ as arrows, where a partial function f is a pair $(\text{dom}f, \text{def}f)$ where $\text{dom}f \subseteq X$ is the *domain of definition* of f and $\text{def}f: \text{dom}f \rightarrow Y$ is a (total) function. Given a partial function $f: X \rightarrow Y$, and some $X' \subseteq X$ we write $f|_{X'}$ for the partial function $(\text{dom}f \cap X', f')$ where $f': \text{dom}f \cap X' \rightarrow Y$ is $\text{def}f$ restricted to the (potentially smaller) domain of definition $\text{dom}f \cap X'$. Similarly, given $Y' \subseteq Y$, write $f^{-1}(Y') = \{x \in \text{dom}f \mid \text{def}f(x) \in Y'\}$. Given $f: X \rightarrow Y$ and $g: Y \rightarrow Z$, their composite is defined by $f \circledast g = (f^{-1}(\text{dom}g), (\text{def}f|_{f^{-1}(\text{dom}g)} \circledast \text{def}g))$. The identity on X is (X, id_X) .

There is a natural partial order between partial functions $X \rightarrow Y$:

$$f \leq g \stackrel{\text{def}}{=} \text{dom}f \subseteq \text{dom}g \wedge g|_{\text{dom}f} = f.$$

It is straightforward to verify that this data makes Par a category, and with \leq , a 2-category.

Categorifying partiality has long history (see e.g., [Cockett and Lack 2002; Robinson and Rosolini 1988]). We recall a classical approach:

Definition 3.2. Suppose that \mathbb{C} has finite limits. Its 2-category of *partial maps*, $\text{Par}(\mathbb{C})$ has:

- 1) **objects** are objects of \mathbb{C} .
- 2) **arrows** are equivalence classes $[m, f]: X \rightarrow Y$ of spans $X \xleftarrow{m} A \xrightarrow{f} Y$ where m is monic. We equate $(m, f) \sim (m', f')$ iff there is an isomorphism α s.t. the following diagram commutes:

$$\begin{array}{ccc} & A & \\ & \alpha & \\ X & \xrightarrow{m} & A & \xrightarrow{f'} & Y \\ & \searrow m' & \swarrow f & & \\ & & & & \end{array}$$

- 3) **2-cells**: $[m, f] \leq [m', f']$ when there exists *any* α that makes the diagram commute.
- 4) **composition** is defined by pullback. Explicitly, the composite of $(m, f): A \rightarrow B$ and $(m', g): B \rightarrow C$ is the outer span of the diagram on the left

$$\begin{array}{ccccc} & & X \wedge X' & & \\ & \swarrow \pi_0 & & \searrow \pi_1 & \\ & X & & X' & \\ m \swarrow & & f \searrow & m' \swarrow & g \searrow \\ A & & B & & C \end{array}$$

where the square with top $X \wedge X'$ is a pullback in \mathbb{C} . Note that it doesn't matter which pullback, since any two choices will give isomorphic spans, and therefore equal morphisms.

- 5) **Identities** are diagonal spans $(1_A, 1_A): A \rightarrow A$.

Given a morphism $(m, f): A \rightarrow B$ in $\text{Par}(\mathbb{C})$, we think of the monic $m: X \rightarrow A$ as a subobject, specifying which part of A the morphism is defined on, and then $f: X \rightarrow B$ tells us what it does.

The following is a straightforward sanity check:

Observation 3.3. There is an isomorphism of (2-)categories $\text{Par} \cong \text{Par}(\text{Set})$.

Just as a model of a total operation of arity n is a function $A^n \rightarrow A$ (an arrow in Set), a model of a partial operation ought to be a partial function $A^n \rightarrow A$ (an arrow in Par). For this reason, it is

important to understand the mathematical status of the cartesian product in Par . Interestingly, Par has categorical products, but these *do not* correspond to the cartesian product of sets.²

3.2 Cartesian Restriction Categories

It is by focusing on the universal property of the cartesian product in Par that we are able to identify a generalisation of Lawvere's approach to partial operations. This is the goal of this section.

Restriction categories were devised to study partial phenomena in an axiomatic setting. Here we give a whirlwind tour, more details can be found in [Cockett et al. 2012; Cockett and Lack 2002, 2007]. In a restriction category, every arrow $f : A \rightarrow B$ has an associated idempotent $\bar{f} : A \rightarrow A$, thought of as the identity function restricted to the domain of definition of f . We call them *domain idempotents*. Arrows where $\bar{f} = 1_A$ are called *total*, and form a subcategory. Further, we have:

Remark 3.4. Any restriction category is poset-enriched, with the ordering defined by

$$f \leq g \Leftrightarrow \bar{f} \circ g = f$$

Functors F that preserve domain idempotents ($F\bar{f} = \overline{Ff}$) are called *restriction functors*. Restriction categories and restriction functors form a category. This extends to a 2-category in which the 2-cells are *lax transformations*. A lax transformation $\alpha : F \rightarrow G$ of restriction functors $F, G : \mathbb{X} \rightarrow \mathbb{Y}$ consists of a family of total maps $\alpha_A : FA \rightarrow GA$ in \mathbb{Y} indexed by the objects A of \mathbb{X} s.t. for every $f : A \rightarrow B$ of \mathbb{X} the usual naturality square *commutes up to inequality*:

$$\begin{array}{ccc} FA & \xrightarrow{\alpha_A} & GA \\ Ff \downarrow & \leq & \downarrow Gf \\ FB & \xrightarrow{\alpha_B} & GB \end{array}$$

where \leq is the ordering introduced above. Call this 2-category RCat^{\leq} . Just as categories with finite products enjoy a universal property in the 2-category Cat , those with finite restriction products have a universal property in RCat^{\leq} . In general, formal limits in RCat^{\leq} are called *restriction limits* [Cockett and Lack 2007]. A *cartesian restriction (CR) category* is a restriction category with finite restriction products.

Observation 3.5 ([Cockett and Lack 2002]). Par is a CR category, with the cartesian product as restriction product.

CR categories have appeared in the literature under a variety of different names, including *p-category with a one-element object* [Robinson and Rosolini 1988] and *partially cartesian category* [Curien and Obtulowicz 1989]. For our development, it is crucial that the data of CR categories can be equivalently captured as follows:

Theorem 3.6 ([Cockett and Lack 2007]). A CR category is the same thing as a symmetric monoidal category where every object is equipped with a commutative comonoid structure that is (**coherent**) and the comultiplication is natural. That is, for any $f : A \rightarrow B$ we have $f \circ \delta_B = \delta_A \circ (f \otimes f)$.

From this perspective a CR category is very close to a cartesian category viewed as a monoidal category through [Theorem 2.22](#). The difference is that we do not ask for the counit of the comonoid to be natural. This has profound consequences: for instance, the same symmetric monoidal category may have more than one such chosen comonoid structure, thus defining different CR categories.

²The categorical product of A and B in Par is $(A + \{\star\}) \times (B + \{\star\}) - \{(\star, \star)\}$. This can be seen via the equivalence $1/\text{Set} \simeq \text{Par}$. Limits in the coslice category $1/\text{Set}$ are calculated pointwise, and the functor $1/\text{Set} \rightarrow \text{Par}$ removes the point

Given the algebraic data, the domain idempotent $\bar{f} : A \rightarrow A$ of an arrow $f : A \rightarrow B$ in a CR category is recovered as:

$$\bar{f} = \text{---} \bullet \left[\begin{array}{c} \boxed{f} \\ \text{---} \end{array} \right] \bullet \text{---}$$

and so in particular the subcategory of \mathbb{X} for which the counit is natural is precisely the subcategory of total maps. Notice that this means the subcategory of total maps of a CR category is cartesian.

Definition 3.7. A CR functor between two CR categories $F : \mathbb{X} \rightarrow \mathbb{Y}$ is a functor that preserves the algebraic structure. That is, $F(A \otimes B) = FA \otimes FB$, $F1 = 1$, $F\delta_A = \delta_{FA}$ and $F\varepsilon_A = \varepsilon_{FA}$.

Remark 3.8. A lax transformation of CR functors may be equivalently specified as a family of maps $\alpha_A : FA \rightarrow GA$ indexed by the objects A of \mathbb{X} s.t. for every $f : A \rightarrow B$ we have $Ff \circ \alpha_B \leq \alpha_A \circ Gf$. We do not need to ask that each α_A is total, since if F and G preserve the cartesian restriction structure, then they are *automatically* total. In particular the diagram on the left gives the inequality on the right, which gives that α_A is total:

$$\begin{array}{ccc} FA & \xrightarrow{\alpha_A} & GA \\ F\varepsilon_A \downarrow & \leq & \downarrow G\varepsilon_A \\ FI & \xrightarrow{\alpha_I} & GI \end{array} \quad \text{---} \bullet \leq \text{---} \boxed{\alpha_A} \bullet \text{---}$$

3.3 Discrete Cartesian Restriction Categories

Restriction products do not quite capture all the properties of Par needed for partial universal algebra. In particular, we require CR categories with the following extra structure:

Definition 3.9. A CR category is said to be *discrete* (DCR category [Cockett et al. 2012]) if for each object A there is an arrow $\mu_A : A \otimes A \rightarrow A$ that is *partial inverse* to δ_A . That is, $\delta_A \circ \mu_A = \bar{\delta}_A = 1_A$ and $\mu_A \circ \delta_A = \bar{\mu}_A$.

We give a novel presentation of DCR categories, inspired by the work of [Giles 2014]. Central to our presentation is the notion of a commutative special Frobenius algebra in which the monoid does not have a unit, which we call a *partial Frobenius algebra*. More precisely:

Definition 3.10. A *partial Frobenius algebra* $(A, \delta_A, \mu_A, \varepsilon_A)$ in a symmetric monoidal category consists of a commutative comonoid $(A, \delta_A, \varepsilon_A)$ and a commutative semigroup (A, μ_A) s.t. (A, δ_A, μ_A) is a semi-Frobenius algebra. Diagrammatically, this is the comonoid structure we have already seen together μ_A , which we depict as  in our string diagrams, subject to the following equations:

$$\begin{array}{ccc} \begin{array}{c} \text{---} \bullet \\ \text{---} \bullet \\ \text{---} \end{array} \begin{array}{c} \text{---} \\ \text{---} \end{array} = \begin{array}{c} \text{---} \\ \text{---} \bullet \\ \text{---} \end{array} \begin{array}{c} \text{---} \\ \text{---} \end{array} & \begin{array}{c} \text{---} \\ \text{---} \end{array} \begin{array}{c} \text{---} \\ \text{---} \end{array} = \begin{array}{c} \text{---} \bullet \\ \text{---} \end{array} \begin{array}{c} \text{---} \\ \text{---} \end{array} & \text{(MCA)} \\ \begin{array}{c} \text{---} \\ \text{---} \bullet \\ \text{---} \end{array} \begin{array}{c} \text{---} \\ \text{---} \end{array} = \begin{array}{c} \text{---} \bullet \\ \text{---} \end{array} \begin{array}{c} \text{---} \\ \text{---} \end{array} = \begin{array}{c} \text{---} \\ \text{---} \bullet \\ \text{---} \end{array} \begin{array}{c} \text{---} \\ \text{---} \end{array} & \begin{array}{c} \text{---} \\ \text{---} \end{array} \begin{array}{c} \text{---} \\ \text{---} \end{array} = \text{---} & \text{(SFROB)} \end{array}$$

Note that there is some redundancy in the equational presentation above, as discussed in [Carboni 1991]. We now extend the characterisation of CR categories given in Theorem 3.6 to DCR categories:

Theorem 3.11. A DCR category is the same thing as a symmetric monoidal category where every object A is equipped with a coherent partial Frobenius algebra structure $(A, \delta_A, \varepsilon_A, \mu_A)$ s.t. the comultiplication is natural. That is, for any $f : A \rightarrow B$ we have $f \circ \delta_B = \delta_A \circ (f \otimes f)$.

DCR categories are intimately connected to categories with finite limits [Cockett et al. 2012]. In particular:

Proposition 3.12. If \mathbb{C} is a category with finite limits, $\text{Par}(\mathbb{C})$ is a DCR category.

Definition 3.13 (the 2-category DCRC^{\leq}). It follows that for any CR functor $F : \mathbb{X} \rightarrow \mathbb{Y}$ between DCR categories, we have $F\mu_A = \mu_{FA}$. CR functors therefore give the notion of morphism between DCR categories. We consider the strict 2-category of DCR categories, restriction functors, and lax transformations, which we call DCRC^{\leq} .

4 PARTIAL LAWVERE THEORIES

In this section we develop a Lawvere-style approach to *partial algebraic theories*, where operations may be partial. Ordinary Lawvere theories are determined by the free cartesian category on a single object \mathbb{F}^{op} ; we are thus interested in the analogue of \mathbb{F}^{op} in the world of DCR categories.

4.1 The Free DCR Category on One Object

Given Theorem 3.11, we have an explicit description for the DCR category on one object: it is the prop $\mathbb{P}\mathbb{F}$ induced from the monoidal theory of partial Frobenius algebras. That is, it has generators $\{ \begin{array}{c} \square \\ \bullet \end{array} \text{---} , \text{---} \begin{array}{c} \square \\ \bullet \end{array} , \bullet \text{---} \bullet \}$ and equations (MCA), (CCM) and (SFROB).

It turns out that one can gain a precise intuition on what $\mathbb{P}\mathbb{F}$ looks like by mimicking the way in which the props \mathbb{F} and its opposite \mathbb{F}^{op} describe familiar algebraic structures. In fact, the prop $\mathbb{C}\mathbb{M}$ of commutative monoids is isomorphic to the prop \mathbb{F} (see Observation 2.18), and similarly, the prop $\mathbb{C}\mathbb{C}$ of commutative comonoids is isomorphic to \mathbb{F}^{op} (Observation 2.21).

The prop $\mathbb{P}\mathbb{F}$ of partial Frobenius algebras that we want to describe here can be given a similar “combinatorial” characterisation relying on the insights of Lack [Lack 2004]. First, we note that the prop $\mathbb{C}\mathbb{A}\mathbb{M}$ induced by the monoidal theory of commutative semigroups ($\{ \begin{array}{c} \square \\ \bullet \end{array} \text{---} \}$) and equations (MCA) is isomorphic to sub-prop $\mathbb{F}_s \subset \mathbb{F}$ of finite sets and *surjective functions*.

Observation 4.1. As props, $\mathbb{C}\mathbb{A}\mathbb{M} \cong \mathbb{F}_s$.

This is intuitive: as observed in Remark 2.19, string diagrams of $\mathbb{C}\mathbb{M}$ allow one to “draw” all functions $[m] \rightarrow [n]$. Doing without the unit means that we can express exactly the surjective ones.

Next, we know from [Lack 2004] that the prop $\mathbb{F}\mathbb{R}\mathbb{O}\mathbb{B}$ induced by the monoidal theory of special Frobenius algebras with generators $\{ \begin{array}{c} \square \\ \bullet \end{array} \text{---} , \bullet \text{---} \bullet , \text{---} \begin{array}{c} \square \\ \bullet \end{array} , \bullet \text{---} \bullet \}$ and equations (CM), (CCM) and (SFROB) is isomorphic to the prop of *cospan*s of finite sets $\text{Cospan}(\mathbb{F})$. An arrow $m \rightarrow n$ here is (an isomorphism class of) a cospan of functions $[m] \xrightarrow{f} [k] \xleftarrow{g} [n]$, and composition is by pushout.

Proposition 4.2 ([Lack 2004]). As props, $\mathbb{F}\mathbb{R}\mathbb{O}\mathbb{B} \cong \text{Cospan}(\mathbb{F})$.

Given that surjective functions are closed under composition and pushouts in \mathbb{F} , we can consider the subprop $\text{Cospan}_s(\mathbb{F})$ of $\text{Cospan}(\mathbb{F})$ with arrows those cospans where the left leg is surjective. Now, combining Observation 4.1 and Proposition 4.2 yields:

Proposition 4.3. As props, $\mathbb{P}\mathbb{F} \cong \text{Cospan}_s(\mathbb{F})$.

This gives us a combinatorial characterisation of $\mathbb{P}\mathbb{F}$. But there is a more familiar and satisfactory way of describing $\text{Cospan}_s(\mathbb{F})$. Given that cospans in \mathbb{C} are spans in \mathbb{C}^{op} , and epimorphisms in \mathbb{C} are monomorphisms in \mathbb{C}^{op} , we see that $\text{Cospan}_s(\mathbb{F}) = \text{Par}(\mathbb{F}^{\text{op}})$, since a cospan in \mathbb{F} with left leg surjective is the same thing as a span in \mathbb{F}^{op} with left leg a monomorphism. Therefore, we obtain:

Proposition 4.4. As props, $\mathbb{P}\mathbb{F} \cong \text{Par}(\mathbb{F}^{\text{op}})$.

4.2 Partial Lawvere Theories

We have seen that \mathbb{F}^{op} is central to the definition of Lawvere theories, being the free cartesian category on one object. The prop $\text{Par}(\mathbb{F}^{\text{op}})$, being the free DCR on one object, plays the corresponding role in the definition of partial Lawvere theories.

Definition 4.5. A partial Lawvere theory \mathcal{L} is a DCR prop.

Spelled out, a partial Lawvere theory is a DCR category \mathcal{L} for which there is an identity-on-objects CR functor $\text{Par}(\mathbb{F}^{\text{op}}) \rightarrow \mathcal{L}$. A morphism of partial Lawvere theories is a functor $h : \mathcal{L} \rightarrow \mathcal{M}$ s.t. the following triangle commutes:

$$\begin{array}{ccc} & \text{Par}(\mathbb{F}^{\text{op}}) & \\ p \swarrow & & \searrow q \\ \mathcal{L} & \xrightarrow{h} & \mathcal{M}. \end{array}$$

This defines the category pLaw of partial Lawvere theories.

Mimicking also the definition of model of a Lawvere theory, we obtain at once the notion of model of a *partial* Lawvere theory:

Definition 4.6 (Model of a partial Lawvere theory). A *model* for a partial Lawvere theory \mathcal{L} is a CR functor $L : \mathcal{L} \rightarrow \text{Par}$. A homomorphism $L \rightarrow L'$ is a *lax* natural transformation $\alpha : L \Rightarrow L'$.

Definition 4.7. The category of models and homomorphisms of a partial Lawvere theory \mathcal{L} is denoted $\text{pMod}_{\mathcal{L}}$. As explained in Remark 3.8, the homomorphisms are *total* functions.

5 PARTIAL EQUATIONAL THEORIES

In order to consider interesting examples of partial Lawvere theories, we need to introduce the notion of *partial equational theory*. For partial structures, these are the syntactic analogue of equational theories, and yield partial Lawvere theories in a similar way to how equational theories yield Lawvere theories.

Monoidal signatures (Definition 2.12) Γ have unrestricted arities and coarities. Instead, a signature Σ of an equational theory (Definition 2.1) has function symbols of arbitrary arities, but—considered as a monoidal signature—all coarities are 1. Partial signatures are an intermediate concept: as for equational theories, coarities > 1 are redundant, but we need to admit symbols of coarity 0.

Definition 5.1. A partial signature $\Delta \stackrel{\text{def}}{=} \Delta_0 + \Delta_1$, where Δ_0 is the set of operations of coarity 0, and Δ_1 is the set of operations of coarity 1. Each $\delta : \Delta_i$ comes with an arity $\text{ar}(\delta) : \mathbb{N}$.

Differently from ordinary equational theories, we cannot use classical terms, which—as discussed in Remark 2.26—are tied to an underlying cartesian structure. Instead, we adapt Recipe 2.37 to DCR categories, obtaining *partial* terms as particular string diagrams. Before we launch into formal definitions, and illustrate them with a variety of examples, let us establish some intuitions for how to read the string diagrams.

- string diagrams represent partial terms, obtained through composing partial operations,
- equalities and inequalities between them are understood in the sense of Kleene,
- the comonoid structure $\{-\frown, \rightarrow\}$ plays a similar role to that described in S2.6.

Recipe 5.2. Given a partial signature Δ , the free DCR prop \mathcal{L}_{Δ} on Δ is the prop induced from the monoidal theory with

- generators $(\Delta + \{ \boxed{\bullet} \dashv \rightarrow, \dashv \rightarrow \boxed{\bullet}, \dashv \bullet \})$
- equations (MCA), (CCM) and (SFROB), together with $m \dashv \boxed{\delta} \rightarrow \boxed{\bullet} = m \dashv \begin{matrix} \boxed{\delta} \\ \dashv \bullet \\ \boxed{\delta} \end{matrix} \dashv \rightarrow$ for each $\delta : \Delta_1$, where $ar(\delta) = m$.

Definition 5.3 (Partial Equational Theory). A *partial equation* is a pair (s, t) where $s, t : \mathcal{L}_\Delta(m, n)$ for some $m, n : \mathbb{N}$; we usually write ‘ $s = t$ ’. A *partial equational theory* is a pair (Δ, G) where Δ is a partial signature and G is a set of partial equations.

We first return to a familiar example.

Example 5.4 ((Partial) Commutative Monoids). We start with the monoidal theory of commutative monoids (Example 2.16), where the multiplication and unit generators are re-coloured to red to avoid a clash. In models, the multiplication operation may be partially defined *and* the unit may be undefined. To define the partial theory of *total* commutative monoids, we’d need to add equations:

$$\boxed{\bullet} \dashv \rightarrow \bullet = \begin{matrix} \bullet \\ \dashv \bullet \\ \bullet \end{matrix} \dashv \rightarrow \bullet \quad \bullet \dashv \rightarrow \bullet = \boxed{} \quad (3)$$

Example 5.5 (Equational Theories). Any equational theory (Σ, E) is an example. One follows Recipe 5.2, adding equations analogous to (3) to specify that every generator in Σ is total. The category of models of this partial theory then agrees with that of the Lawvere theory $\mathcal{L}_{(\Sigma, E)}$.

The following elementary examples illustrate the novel features of partial Lawvere theories, highlighting the way in which they differ from classical (i.e., total) Lawvere theories.

Example 5.6 (Equivalence Relations). Consider the partial Lawvere theory consisting of a single binary operation R with coarity 0, together with equations expressing symmetry and reflexivity:

$$\boxed{R} : \begin{matrix} \dashv \bullet \\ \dashv \bullet \end{matrix} \dashv \rightarrow \boxed{R} = \boxed{R} \quad \bullet \dashv \rightarrow \boxed{R} = \bullet$$

Note that *inequations* of terms, as in Remark 3.4, do not add expressivity. As such, we may use them freely when specifying partial Lawvere theories. Transitivity is intuitively captured by the inequation on the left, which, unfolding the definition of \leq , is precisely the equation on the right:

$$\begin{matrix} \dashv \bullet \\ \dashv \bullet \end{matrix} \dashv \rightarrow \boxed{R} \leq \begin{matrix} \dashv \bullet \\ \dashv \bullet \end{matrix} \dashv \rightarrow \boxed{R} \quad = \quad \begin{matrix} \dashv \bullet \\ \dashv \bullet \\ \dashv \bullet \end{matrix} \dashv \rightarrow \begin{matrix} \boxed{R} \\ \dashv \bullet \\ \boxed{R} \\ \dashv \bullet \\ \boxed{R} \end{matrix}$$

A model \mathcal{A} of this theory consists of a set A together with an equivalence relation $=_A \subseteq A \times A$ corresponding to the domain of definition of $\mathcal{A}(R)$. A morphism $F : \mathcal{A} \rightarrow \mathcal{B}$ is a function $F : A \rightarrow B$ with $a =_A b \Rightarrow Fa =_B Fb$, which arises from the requirement that F is a lax transformation:

$$\begin{matrix} A \\ A \end{matrix} \dashv \rightarrow \boxed{R} \leq \begin{matrix} A \\ A \end{matrix} \dashv \rightarrow \begin{matrix} \boxed{F} \\ \dashv \bullet \\ \boxed{F} \end{matrix} \dashv \rightarrow \boxed{R}$$

Thus, the variety corresponding to this theory is the category of *Bishop sets (setoids)* [Palmgren 2009].

Example 5.7 (Partial Combinatory Algebras). A *partial combinatory algebra* (PCA) is a set A with a binary partial operation $_ \bullet _ : A \times A \rightarrow A$, and elements $s, k \in A$ s.t. for any $x, y, z \in A$:

- (i) $(k \bullet x) \bullet y = x$
- (ii) $((s \bullet x) \bullet y) \bullet z = (x \bullet z) \bullet (y \bullet z)$
- (iii) $(s \bullet x) \bullet y$ is defined

where “=” is Kleene equality. The partial Lawvere theory of PCAs has three generators:

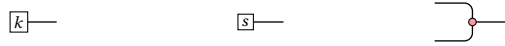

and equations that ensure the totality of k, s , i.e. they define elements of the carrier, and (iii):

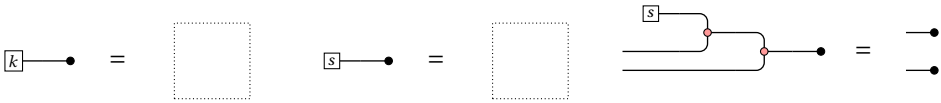

as well as equations for (i) and (ii):

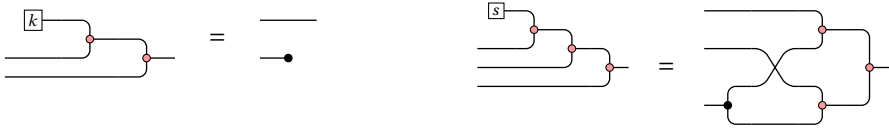

The variety here is the category of PCAs and homomorphisms preserving the applicative structure.

Example 5.8 (Pairing Functions). Consider the partial Lawvere theory with two operations which we think of as *pairing* and *unpairing* respectively, subject to the equation on the right:



Models are sets equipped with a *pairing function*, and model morphisms map pairs to pairs. For example, \mathbb{N} and Cantor’s pairing function, or Λ – the set of untyped λ -terms – with the usual pairing and projection functions. Note that our equation makes pairing a section, and so it is total.

6 MULTI-SORTED EQUATIONAL THEORIES

In this section we present a progression of multi-sorted partial Lawvere theories for categories with different kinds of structure. While our development of partial Lawvere theories has thus far focused on the single-sorted case, the move to multi-sorted theories contains no surprises, so we omit the details. The short version is that props are replaced with *coloured* props, and the sorting discipline changes accordingly. The examples that follow are developed incrementally: Each step adds more categorical structure to the models by adding the appropriate operations and equations to the theory, culminating in the partial Lawvere theory of cartesian closed categories.

Example 6.1 (Directed Graphs). We begin with the partial Lawvere theory of *directed graphs*, which has a sort O of vertices and a sort A of edges, together with source and target operations:

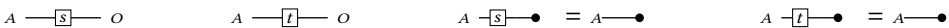

The associated variety is the category of directed graphs, as model morphisms F must satisfy:

$$\boxed{s} \text{---} \boxed{F} \text{---} = \text{---} \boxed{F} \text{---} \boxed{s} \text{---} \quad \text{---} \boxed{f} \text{---} \boxed{F} \text{---} = \text{---} \boxed{F} \text{---} \boxed{f} \text{---}$$

Example 6.2 (Reflexive Graphs). Extending Example 6.1, we ask that each vertex has a self-loop:

$$o \text{---} \boxed{id} \text{---} A \quad o \text{---} \boxed{id} \text{---} \bullet = o \text{---} \bullet \quad o \text{---} \boxed{id} \text{---} \boxed{s} \text{---} o = o \text{---} o = o \text{---} \boxed{id} \text{---} \boxed{f} \text{---} o$$

then morphisms of models are required to preserve the self-loop, so the associated variety is the category of *reflexive graphs*. Notice that along with Example 6.1, this could also be presented as a (total) 2-sorted Lawvere theory, since all the operations are total.

Example 6.3 (Categories). To capture *categories* we extend Example 6.2 with a composition operator, which is defined when the target of the first arrow matches the source of the second:

$$\begin{array}{c} A \\ \text{---} \\ A \end{array} \text{---} A \quad \begin{array}{c} \boxed{f} \\ \text{---} \\ \bullet \\ \text{---} \\ \boxed{s} \end{array} \bullet = \begin{array}{c} \text{---} \\ \bullet \end{array}$$

and equations insisting composition is associative and unital, with identities given by the self-loops:

$$\begin{array}{c} A \\ \text{---} \\ A \end{array} \text{---} \begin{array}{c} \text{---} \\ \bullet \end{array} \text{---} A = \begin{array}{c} A \\ \text{---} \\ A \end{array} \text{---} \begin{array}{c} \text{---} \\ \bullet \end{array} \text{---} A \quad A \text{---} \begin{array}{c} \boxed{s} \text{---} \boxed{id} \\ \text{---} \\ \bullet \end{array} \text{---} A = A \text{---} A = A \text{---} A \text{---} \begin{array}{c} \boxed{f} \text{---} \boxed{id} \\ \text{---} \\ \bullet \end{array} \text{---} A$$

Model morphisms are precisely functors. It is worth noting that this involves an inequality:

$$\begin{array}{c} \text{---} \\ \bullet \end{array} \text{---} \boxed{F} \text{---} \leq \begin{array}{c} \boxed{F} \\ \text{---} \\ \bullet \end{array}$$

This states that if f and g are composable then so are Ff and Fg , and in particular $F(f \circ g) = Ff \circ Fg$. If this were an equality, it would insist also that if Ff and Fg are composable, then so are f and g , which is not always the case. Of course, the associated variety is the category of small categories.

Example 6.4 (Strict Monoidal Categories). Next, we extend Example 6.3 by asking for a functorial binary operation \otimes on O and A together with a unit constant \top of O :

$$\begin{array}{c} \boxed{\top} \text{---} o : \quad \boxed{\top} \text{---} \bullet = \text{---} \end{array} \quad \begin{array}{c} o \\ \otimes \\ o \end{array} \text{---} o : \quad \begin{array}{c} o \\ \otimes \\ o \end{array} \text{---} \bullet = \begin{array}{c} o \text{---} \bullet \\ o \text{---} \bullet \end{array}$$

$$\begin{array}{c} A \\ \otimes \\ A \end{array} \text{---} \bullet = \begin{array}{c} A \text{---} \bullet \\ A \text{---} \bullet \end{array} \quad \begin{array}{c} A \\ \otimes \\ A \end{array} \text{---} \boxed{s} \text{---} o = \begin{array}{c} A \text{---} \boxed{s} \\ \otimes \\ A \text{---} \boxed{s} \end{array} \text{---} o$$

$$\begin{array}{c} A \\ \otimes \\ A \end{array} \text{---} \boxed{f} \text{---} o = \begin{array}{c} A \text{---} \boxed{f} \\ \otimes \\ A \text{---} \boxed{f} \end{array} \text{---} o \quad \begin{array}{c} A \\ \otimes \\ A \end{array} \text{---} \begin{array}{c} \text{---} \\ \bullet \end{array} \text{---} A = \begin{array}{c} A \text{---} \text{---} \\ \otimes \\ A \text{---} \text{---} \end{array} \text{---} A$$

Additionally, we require equations to the effect that \otimes is associative and unital:

$$\begin{array}{c} o \\ \otimes \\ o \end{array} \text{---} \begin{array}{c} \otimes \\ o \end{array} \text{---} o = \begin{array}{c} o \text{---} \otimes \\ \otimes \\ o \end{array} \text{---} o \quad \begin{array}{c} A \\ \otimes \\ A \end{array} \text{---} \begin{array}{c} \otimes \\ A \end{array} \text{---} A = \begin{array}{c} A \text{---} \otimes \\ \otimes \\ A \end{array} \text{---} A$$

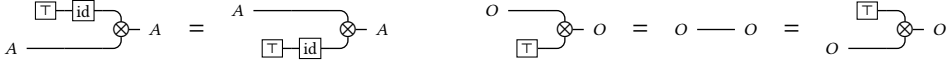

Now the associated variety is the category of strict monoidal categories and strict monoidal functors.

Example 6.5 (Symmetric Strict Monoidal Categories). To capture *symmetric monoidal categories*, we extend Example 6.4 with a binary operation $\sigma : O \otimes O \rightarrow A$ for the braiding maps, subject to:

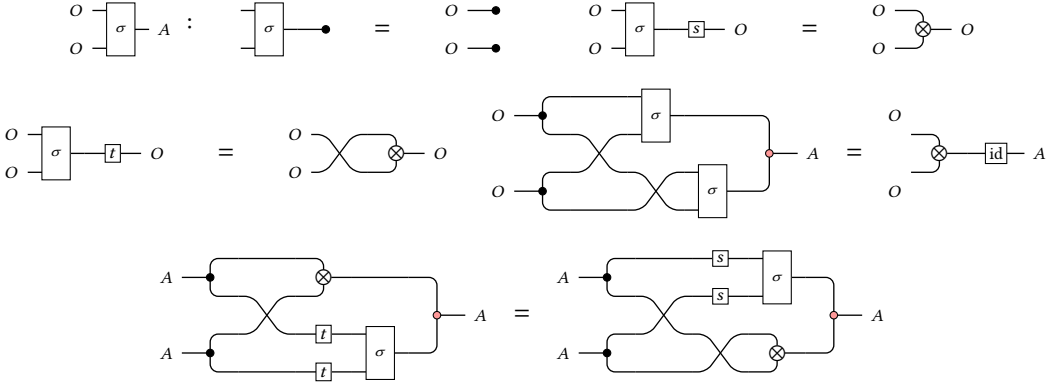

This gives the variety of strict monoidal categories and symmetric strict monoidal functors.

Example 6.6 (Cartesian Restriction Categories). In light of Theorem 3.6, we can capture *CR categories* by extending Example 6.5 with operations $\delta : O \rightarrow A$ and $\varepsilon : O \rightarrow A$ corresponding to the comultiplication and counit of the comonoid structure:

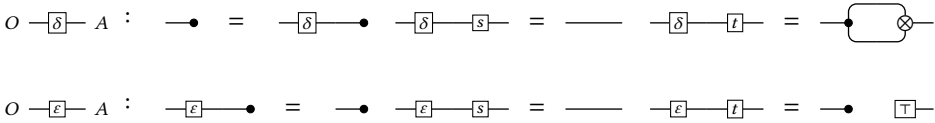

along with equations insisting that δ and ε are coherent with respect to the monoidal structure:

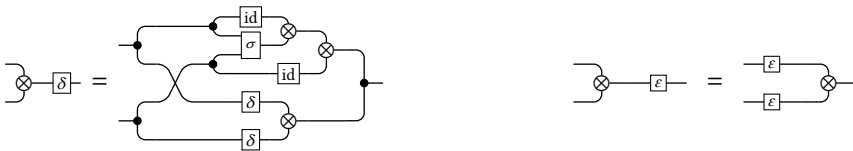

And finally equations for the commutative comonoid axioms, and naturality of δ :

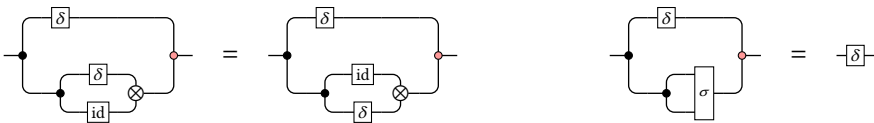

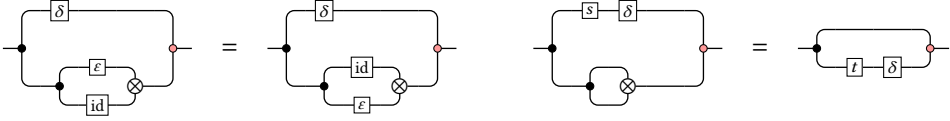

The associated variety is the category of CR categories and CR functors.

Example 6.7 (Discrete Cartesian Restriction Categories). **Theorem 3.11** makes it easy to capture DCR categories by extending Example 6.6 with $\mu : O \rightarrow A$ satisfying the Frobenius and special equations: there is a $O \dashv \mu \vdash A$ such that

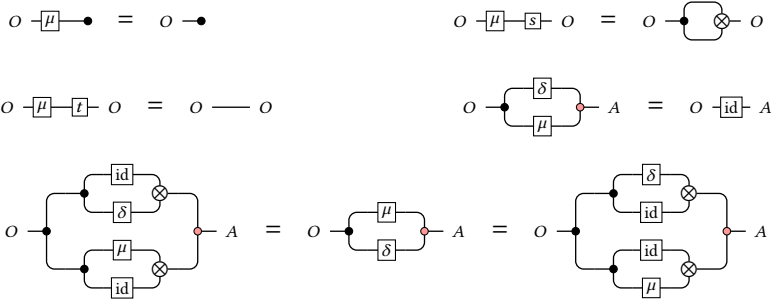

The variety is the category of strict DRC categories and strict CR functors (since they preserve μ).

Example 6.8 (Cartesian Categories). To capture cartesian categories instead, we can extend Example 6.6 with one equation, ensuring that ϵ is natural:

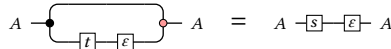

Then by Theorem 2.22, this gives the variety of strict cartesian categories and strict cartesian functors.

Example 6.9 (Cartesian Closed Categories). Finally, to capture cartesian closed categories we extend Example 6.8 with an operator $\text{exp} : O \otimes O \rightarrow O$, the idea being that $\text{exp}(A, B)$ is the internal hom $[A, B]$, along with an operator $\text{ev} : O \otimes O \rightarrow O$ that gives the corresponding evaluation map:

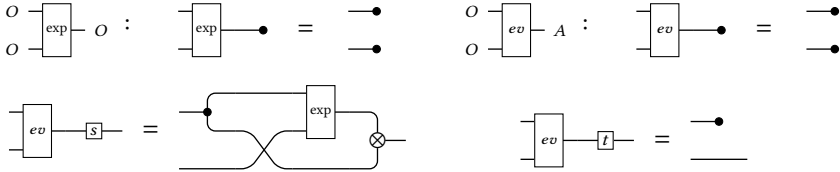

along with an operation λ and equations stating, intuitively, that $\lambda(X, A, B, f)$ is defined precisely in case $f : X \times A \rightarrow B$, and yields a map $\lambda(X, A, B, f) : X \rightarrow [A, B]$ as in:

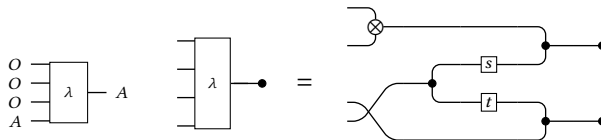

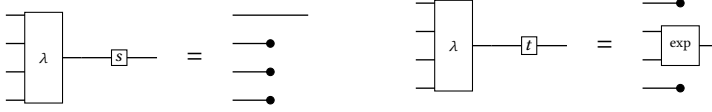

also equations insisting that if $f : X \times A \rightarrow B$ then $(\lambda(X, A, B, f) \times 1) \circ ev = f$ holds:

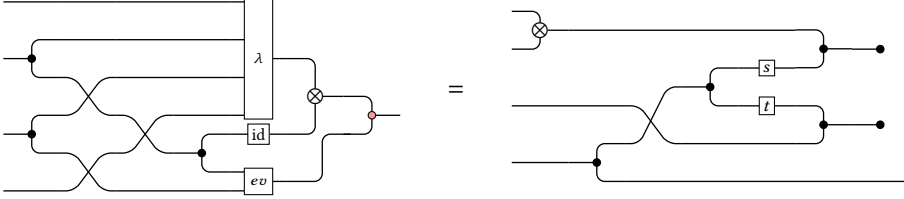

and that if $g : X \rightarrow [A, B]$ then $\lambda(X, A, B, (g \times 1) \circ ev) = g$ holds:

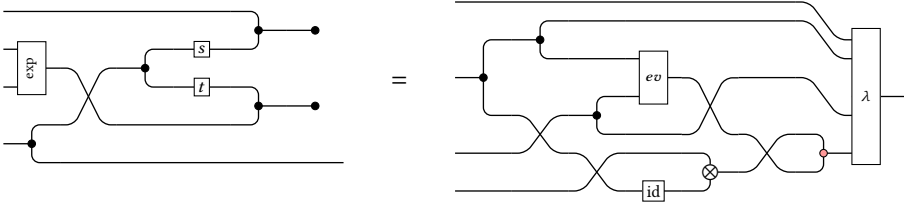

Now the associated variety is the category of strict cartesian closed categories and strict cartesian closed functors: these preserve hom-objects and, when $\lambda(X, A, B, f)$ is defined, satisfy $F\lambda(X, A, B, f) = \lambda(FX, FA, FB, Ff)$. This presentation of cartesian closed categories is essentially due to Freyd: a version of it is given immediately after the first appearance of the notion of essentially algebraic theory in [Freyd 1972], albeit somewhat informally, and using very different syntax.

7 THE VARIETY THEOREM FOR PARTIAL THEORIES

Here we classify the categories of models of partial Lawvere theories. These turn out to be exactly the locally finitely presentable (LFP) categories [Adamek and Rosický 1994, 1A]. LFP categories have an important position in categorical algebra, due to deep connections with model theory [Adamek and Rosický 1994, Ch. 5] and [Makkai and Paré 1989], homotopy theory [Dugger 2001], and universal algebra [Adamek and Rosický 1994, Ch. 3].

7.1 The Unsorted Case

Definition 7.1. In a category C , an object C is *finitely presentable* if the hom-functor $C(C, -)$ preserves directed colimits (see [Adamek and Rosický 1994, 1.1] for the definition).

This notion might appear obscure to the reader unfamiliar with categorical logic; [Adamek and Rosický 1994, 1.2] contains lots of examples to help the reader build their intuition: for instance, an object of the category of sets is finitely presentable if and only if it is finite, and a (commutative) monoid is finitely presentable if and only if it admits a presentation $\langle G \mid R \rangle$ where both G (set of generators) and R (set of relations) are finite sets: this happens for many other algebraic structures, and thus motivates the definition.

Definition 7.2 (Locally finitely presentable category). [Adamek and Rosický 1994, Def. 1.9] A locally finitely presentable (LFP) category \mathcal{K} is a cocomplete category s.t. there is a small full

subcategory $\mathcal{A} \subset \mathcal{K}$ of finitely presentable objects, and such that every object of \mathcal{K} is a directed colimit of objects of \mathcal{A} .

As in the classical case (Remark 2.30), the most crisp statement of the variety theorem is for the unsorted case. Just as an unsorted Lawvere theory is exactly a (small) cartesian category, we define an *unsorted partial Lawvere theory* to be a (small) DCR category, and the corresponding notion of morphism to be a CR functor. Then:

Categories of models of partial theories are exactly LFP categories.

Indeed, we have a similar contravariant adjunction to that of Theorem 2.35, if LFP is a 2-category having 1-cells $R : \mathcal{K} \rightarrow \mathcal{K}'$ the right adjoint functors R preserving directed colimits, and 2-cells all natural transformations $\alpha : R \Rightarrow R'$. A motivation for this apparently peculiar choice of 1-cells can be found in our Observation 2.31; it is exactly as our Definition 2.34, provided one replaces “sifted” colimit with “directed”.

Theorem 7.3. There is a 2-adjunction

$$\text{Th} : \text{LFP} \rightleftarrows (\text{DCRC}^{\leq})^{\text{op}} : \text{Mod}, \tag{4}$$

where DCRC^{\leq} is the 2-category of DCR categories of our Definition 3.13 and LFP is the 2-category of LFP categories. Moreover, the unit of this adjunction is an equivalence, namely there is a natural equivalence of categories between $\mathcal{K} \in \text{LFP}$ and $\text{Mod}(\text{Th}(\mathcal{K}))$, i.e. each LFP category is equivalent to the category of models of its induced theory.

The proof of Theorem 7.3 is split into two parts, as illustrated below:

$$\begin{array}{ccc}
 (\text{DCRC}^{\leq})^{\text{op}} & \xleftarrow{\quad 1 \quad} & (\text{Lex})^{\text{op}} \\
 & \swarrow \text{---} & \searrow \text{---} \\
 & & \text{LFP}
 \end{array}
 \tag{5}$$

- 1) we show that Lex –the 2-category of categories \mathcal{A} with finite limits, functors $\mathcal{A} \rightarrow \mathcal{A}'$ preserving finite limits, and natural transformations– is reflective in the 2-category DCRC^{\leq} . This is the original, technical core of Theorem 7.3.
- 2) we connect Lex^{op} and LFP with a contravariant biequivalence of 2-categories. This is a classical result called *Gabriel-Ulmer duality*.

Composing the two, we obtain Theorem 7.3.

We will start from the first of the two tasks, providing an adjunction of 2-categories as follows.

$$K_t : \text{DCRC}^{\leq} \rightleftarrows \text{Lex} : \text{Par}$$

We first describe the left adjoint K_t , then the right adjoint Par , and conclude by showing that they define an adjunction.

Splitting Domain Idempotents. The functor K_t arises via a modified Karoubi envelope, also called *Cauchy completion* in [Borceux and Dejean 1986]. Recall that an idempotent $a : A \rightarrow A$ in a category *splits* if there is a commutative diagram

$$\begin{array}{ccc}
 & X & \xrightarrow{s} A \\
 1_x \nearrow & \uparrow r & \nearrow a \\
 X & \xrightarrow{s} & A
 \end{array}$$

Restriction categories in which all of the domain idempotents split are called *split* restriction categories. An example is $\text{Par}(\mathbb{C})$: for any arrow $(m, f) : A \rightarrow B$, $(m, f) = (m, m) : A \rightarrow A$ splits

with $s = (1, m)$ and $r = (m, 1)$. Notice that this means the domain of definition of (m, f) is a subobject of A . This is a good way to think of split domain idempotents in general: for \bar{f} to be split in a restriction category is for the domain of definition of $f : A \rightarrow B$ to be a subobject of A .

For any restriction category \mathbb{X} we can construct a split restriction category $K(\mathbb{X})$ that contains \mathbb{X} as a subcategory. Its subcategory of *total* maps $K_t(\mathbb{X})$ is of particular interest.

Definition 7.4. Let \mathbb{X} be a DCRC. Then $K_t(\mathbb{X})$ is the category where

- 1) objects are pairs (A, a) with A an object of \mathbb{X} and $a : A \rightarrow A$ a domain idempotent in \mathbb{X} ;
- 2) arrows $f : (A, a) \rightarrow (B, b)$ are arrows $f : A \rightarrow B$ of \mathbb{X} such that $\bar{f} = a$ and $f \circ b = f$;
- 3) composition is given by composition in \mathbb{X} ;
- 4) The identity on (A, a) is given by a .

It is routine to verify that this forms a category. Crucially, if \mathbb{X} is a DCRC, then the subcategory $K_t(\mathbb{X})$ of *total* maps of $K(\mathbb{X})$ has finite limits [Cockett et al. 2012]:

Lemma 7.5. For any DCRC \mathbb{X} , $K_t(\mathbb{X})$ has finite limits.

We now show that this extends to a 2-functor $K_t : \text{DCRC}^{\leq} \rightarrow \text{Lex}$. If \mathbb{X} and \mathbb{Y} are DCRCs and $F : \mathbb{X} \rightarrow \mathbb{Y}$ is a CR functor, then there is a functor $K_t(F) : K_t(\mathbb{X}) \rightarrow K_t(\mathbb{Y})$ defined by $K_t(F)(A, a) = (FA, Fa)$ on objects and $K_t(F)(f) = f$ on arrows. It follows from our characterization of CR functors in terms of the partial Frobenius algebra structure that $K_t(F)$ preserves finite limits, giving the action of our 2-functor K_t on 1-cells. The action of K_t on 2-cells is given as follows:

Lemma 7.6. If $F, G : \mathbb{X} \rightarrow \mathbb{Y}$ are CR functors between DCR categories and $\alpha : F \rightarrow G$ is a lax transformation, define $K_t(\alpha) : K_t(F) \rightarrow K_t(G)$ by letting $K_t(\alpha)$ at (A, a) in $K_t(\mathbb{X})$ be:

$$K_t(\alpha)_{(A,a)} = Fa \circ \alpha_A : (FA, Fa) \rightarrow (GA, Ga)$$

Then $K_t(\alpha)$ is a natural transformation.

At this point we need only show that K_t preserves composition and identities for 1-cells and 2-cells, which in both cases is straightforward.

Lemma 7.7. $K_t : \text{DCRC}^{\leq} \rightarrow \text{Lex}$ is a 2-functor.

Partial Functions Revisited. Here we show that the Par construction (S3.1) also extends to a 2-functor $\text{Par} : \text{Lex} \rightarrow \text{DCRC}^{\leq}$. If \mathbb{C} and \mathbb{D} are categories with finite limits and $F : \mathbb{C} \rightarrow \mathbb{D}$ is a finite-limit preserving functor, then we obtain a CR functor $\text{Par}(F) : \text{Par}(\mathbb{C}) \rightarrow \text{Par}(\mathbb{D})$, defined on objects by $\text{Par}(F)(A) = F(A)$, and on arrows by

$$\begin{array}{ccc} & X & \\ m \swarrow & & \searrow f \\ A & & B \end{array} \quad \xrightarrow{\text{Par}(F)} \quad \begin{array}{ccc} & FX & \\ Fm \swarrow & & \searrow Ff \\ FA & & FB \end{array}$$

Since F preserves finite limits, we have that $\text{Par}(F)(\delta_A) = (F1_A, F\Delta_A) = (1_{FA}, \Delta_{FA}) = \delta_{FA} = \delta_{\text{Par}(F)(A)}$ and $\text{Par}(F)(\varepsilon_A) = (F1_A, F!_A) = (1_{FA}, !_A) = \varepsilon_{\text{Par}(F)(A)}$, so $\text{Par}(F)$ preserves the CR structure. This defines the action of Par on 1-cells. We present the action of Par on 2-cells as a lemma:

Lemma 7.8. If $F, G : \mathbb{C} \rightarrow \mathbb{D}$ are finite limit preserving functors between categories with finite limits and $\alpha : F \rightarrow G$ is a natural transformation, define $\text{Par}(\alpha) : \text{Par}(F) \rightarrow \text{Par}(G)$ by defining the component of $\text{Par}(\alpha)$ at A in \mathbb{C} to be:

$$\begin{array}{ccc} & FA & \\ 1_{FA} \swarrow & & \searrow \alpha_A \\ FA & \text{Par}(\alpha)_A & GA \end{array}$$

Then $\text{Par}(\alpha) : \text{Par}(F) \rightarrow \text{Par}(G)$ is a lax transformation.

It remains only show that Par preserves composition and identities at the level of 1-cells and 2-cells, which is immediate in both cases. We therefore have:

Lemma 7.9. $\text{Par} : \text{Lex} \rightarrow \text{DCRC}^{\leq}$ is a 2-functor.

Adjointness. The following result is original, and builds on [Cockett and Lack 2002, Corollary 3.5]; however, there the 2-cells of the categories involved are different.

Theorem 7.10. There is a 2-adjunction $K_t : \text{DCRC}^{\leq} \rightleftarrows \text{Lex} : \text{Par}$.

It is worth describing the unit and counit of our adjunction. The unit $\eta : 1 \rightarrow \text{Par} \cdot K_t$ is given by the canonical inclusion $\eta_{\mathbb{X}} : \mathbb{X} \rightarrow \text{Par}(K_t(\mathbb{X}))$ defined by

$$\begin{array}{ccc}
 A \xrightarrow{f} B & \xrightarrow{\eta_{\mathbb{X}}} & (A, \bar{f}) \\
 & & \swarrow \bar{f} \quad \searrow f \\
 & & (A, 1_A) \quad (B, 1_B)
 \end{array}$$

The counit $\varepsilon : K_t \cdot \text{Par} \rightarrow 1$ is defined in terms of the equivalence of categories $K(\mathbb{X}) \simeq \mathbb{X}$ between any split restriction category \mathbb{X} and the result of formally splitting its domain idempotents. In particular, since $\text{Par}(\mathbb{C})$ is always split, we obtain an equivalence of categories $K(\text{Par}(\mathbb{C})) \simeq \text{Par}(\mathbb{C})$. Restricting this to the subcategories of total maps gives defines our counit $\varepsilon_{\mathbb{C}} : K_t(\text{Par}(\mathbb{C})) \simeq \mathbb{C}$. In particular, the fact that the counit is a natural equivalence gives:

Lemma 7.11. Lex is a reflective (2-)subcategory of DCRC^{\leq} .

Gabriel-Ulmer duality. To complete the triangle (5), we recall a theorem first shown by P. Gabriel and F. Ulmer [Gabriel and Ulmer 1971], establishing a contravariant equivalence between the 2-category LFP of locally finitely presentable categories and the 2-category Lex of categories with finite limits.

The duality asserts that a locally finitely presentable category \mathcal{K} can be reconstructed from its subcategory \mathcal{K}_{ω} of finitely presentable objects. A good reference for the proof is [Centazzo and Vitale 2002, Th. 3.1].

Theorem 7.12 (Gabriel-Ulmer duality). There is a biequivalence of 2-categories

$$\text{Lex}^{\text{op}} \rightleftarrows \text{LFP}$$

between Lex, the 2-category of small categories with finite limits, where 1-cells are functors preserving finite limits and 2-cells are the natural transformations, and LFP, the 2-category of locally finitely presentable categories, where 1-cells are right adjoints preserving directed colimits.

7.2 Sorted Gabriel-Ulmer Duality

A similar version of the above theorem holds if, instead of considering theories of all possible sorts, we fix once and for all a single cardinality for the sorts \mathfrak{S} . Such “relative” version of Gabriel-Ulmer duality is useful to recover the classical Lawvere-style approach of single- and many-sorted theories.

Definition 7.13. We call $L\mathfrak{S}$ the free category with finite limits over the discrete set \mathfrak{S} . When \mathfrak{S} is the singleton we will use the shortened notation $L1$.

Definition 7.14. A \mathfrak{S} -sorted category with finite limits (\mathcal{A}, p) is an object in $(\text{Lex})^{\text{op}}/L\mathfrak{S}$ whose specifying functor $p : L\mathfrak{S} \rightarrow \mathcal{A}$ is bijective on objects. $(\mathfrak{S}\text{-Lex})^{\text{op}}$ is the full 2-subcategory of \mathfrak{S} -sorted categories with finite limits.

Definition 7.15. A \mathfrak{S} -sorted locally finitely presentable category (\mathcal{K}, U) is an object in $\text{LFP}/[\mathfrak{S}, \text{Set}]$ whose specifying functor $U : \mathcal{K} \rightarrow [\mathfrak{S}, \text{Set}]$ is conservative. $(\mathfrak{S}\text{-LFP})^{\text{op}}$ is the full 2-subcategory of \mathfrak{S} -sorted locally finitely presentable categories.

Theorem 7.16 (Sorted Gabriel-Ulmer duality). There is a biequivalence of 2-categories

$$\text{Mod}_{\mathfrak{S}} : (\mathfrak{S}\text{-Lex})^{\text{op}} \rightleftarrows \mathfrak{S}\text{-LFP} : \text{Th}_{\mathfrak{S}}.$$

We can use the sorted version of Gabriel-Ulmer duality to infer the sorted version of the syntax-semantics duality for multi-sorted partial Lawvere theories.

Theorem 7.17. There is an 2-adjunction, whose unit is an equivalence,

$$\mathfrak{S}\text{-LFP} \rightleftarrows (\mathfrak{S}\text{-pLaw})^{\text{op}},$$

where $\mathfrak{S}\text{-pLaw}$ is the 2-category of “ \mathfrak{S} -sorted partial Lawvere theories”, understood as the analogue of Remark 2.30 for partial theories (see Definition 4.5), and $\mathfrak{S}\text{-LFP}$ is the 2-category of \mathfrak{S} -sorted locally finitely presentable categories.

SKETCH OF PROOF. The proof is divided into intermediate steps: each tag on the following two diagrams indicates the section where the proof of the adjunction, or equivalence, is given.

$$\begin{array}{ccc} (\mathfrak{S}\text{-pLaw})^{\text{op}} & \xleftarrow{\star} & (\mathfrak{S}\text{-Lex})^{\text{op}} \\ & \swarrow \text{dashed} & \nearrow \text{7.16} \\ & \mathfrak{S}\text{-LFP} & \end{array} \qquad \begin{array}{ccc} (\text{DCRC}^{\leq})^{\text{op}} & \xleftarrow{\text{7.10}} & (\text{Lex})^{\text{op}} \\ & \swarrow \text{dashed} & \nearrow \text{7.12} \\ & \text{LFP} & \end{array}$$

The claim in (\star) is the only one that needs to be proven. Yet it is also the most trivial one. We will deduce it directly from Theorem 7.10. Indeed if Lex is reflective in DCRC^{\leq} , $(\text{Lex})^{\text{op}}/L\mathfrak{S}$ is coreflective in $(\text{DCRC}^{\leq})^{\text{op}}/\text{Par}(L\mathfrak{S})$, now observe that $\text{Par}(L\mathfrak{S})$ is precisely the free discrete cartesian restriction category over \mathfrak{S} . The desired result follows passing to functors bijective on objects in the slice. \square

Observation 7.18. In analogy with 2.33, we can show that sorted partial Lawvere theories have free models. For the single-sorted case, let $p : \text{Par}(\mathbb{F}^{\text{op}}) \rightarrow \mathcal{L}$ be a partial Lawvere theory. Indeed we can look at it as a morphism in DCRC^{\leq} , then the previous theorem produces an adjunction $F \dashv \text{Mod}_p$

$$F : \text{Mod}_{\text{Par}(\mathbb{F}^{\text{op}})} \rightleftarrows \text{Mod}_{\mathcal{L}} : \text{Mod}_p.$$

The functor Mod_p coincides with the *forgetful functor*. Its left adjoint F provides free objects.

8 CONCLUSIONS AND FUTURE WORK

We introduced partial Lawvere theories and their associated notion of partial equational theory. Our definitions are guided by the appropriate universal property, replacing cartesian categories with discrete cartesian restriction categories. Knowing the right universal property determines our choice of syntax, isolating the correct class of string diagrams that replace classical terms. This enables the standard methodology of presenting a theory by means of a signature and equations, while avoiding ad-hoc notations and eliminating the subtleties of reasoning about partial structures.

The extension is conservative: every equational theory yields a partial equational theory such that the categories of models coincide, even though our models are in Par rather than in Set . The recently proposed *Frobenius theories* [Bonchi et al. 2017] take their models in the category of relations Rel , and are guided by the structure of cartesian bicategories of relations [Carboni and Walters 1987]. Every partial equational theory yields a Frobenius theory and again, the categories

of models coincide. We feel that our notion is a sweet-spot. First, we have shown that our notion of partial theories is expressive, capturing a number of important examples. Second, we retain much of the richness of the semantic picture, via a canonical variety theorem and existence of free models.

There is much future work. The fact that the syntax introduced here is inherently partial makes it well-suited to applications in computing. In particular there is an evident notion of *computable model* for partial Lawvere theories, namely those models valued in the category of sets and partial recursive functions. The corresponding *computable varieties* seem to be interesting for programming language semantics, and therefore worthy of study. A further step would be the lifting of this situation to a more synthetic category of computable functions, such as a *Turing category* [Cockett and Hofstra 2008] or *monoidal computer* [Pavlovic 2013].

An important part of categorical universal algebra is played by monads, a point of view that we have not considered here. Indeed, Lawvere theories can be seen as *finitary monads* [Linton 1966], with the category of algebras giving the associated variety. This connection has been a fruitful one, relating areas of research that are, on the surface, very different, see e.g. [Cheng 2020; Loday and Vallette 2012; Markl et al. 2002]. A natural question is whether there is an analogous approach for partial algebraic theories. We conjecture that there is, with certain formal monads [Street 1972] in the 2-category DCRC^{\leq} playing the role of finitary monads. We expect that other constructions of categorical universal algebra (e.g. [Freyd 1966; Power 2006]) will have corresponding partial accounts.

ACKNOWLEDGMENTS

Di Liberti was supported by the Grant Agency of the Czech Republic project EXPRO 20-31529X and RVO: 67985840. Loregian, Nester and Sobociński were supported by the ESF funded Estonian IT Academy research measure (project 2014-2020.4.05.19-0001).

REFERENCES

- J. Adámek, F.W. Lawvere, and J. Rosický. 2003. On the duality between varieties and algebraic theories. *Algebra universalis* 49, 1 (2003), 35–49.
- J. Adámek and J. Rosický. 1994. *Locally Presentable and Accessible Categories*. Cambridge University Press.
- J. Adámek, J. Rosický, and E.M. Vitale. 2011. Algebraic theories. *Cambridge Tracts in Mathematics* 184 (2011), 1.
- I. Bethke. 1988. *Notes on Partial Combinatory Algebras*. Ph.D. Dissertation. Universiteit von Amsterdam.
- G. Birkhoff. 1935. On the structure of abstract algebras. In *Mathematical proceedings of the Cambridge philosophical society*, Vol. 31. Cambridge University Press, 433–454.
- S. L. Bloom and Z. Ésik. 1993. Iteration Theories: The Equational Logic of Iterative Processes.
- F. Bonchi, D. Pavlovic, and P. Sobocinski. 2017. Functorial Semantics for Relational Theories. *arXiv preprint arXiv:1711.08699* (2017).
- F. Bonchi, P. Sobociński, and F. Zanasi. 2018. Deconstructing Lawvere with Distributive Laws. *Journal of Logical and Algebraic Methods in Programming* 95 (2018), 128–146. <https://doi.org/10.1016/j.jlamp.2017.12.002>
- F. Borceux and D. Dejean. 1986. Cauchy completion in category theory. *Cahiers de Topologie et Géométrie Différentielle Catégoriques* 27, 2 (1986), 133–146.
- A. Carboni. 1991. Matrices, relations, and group representations. *Journal of Algebra* 136, 2 (1991), 497–529.
- A. Carboni and R.F.C. Walters. 1987. Cartesian Bicategories I. *Journal of Pure and Applied Algebra* 49 (1987), 11–32.
- C. Centazzo. 2004. *Generalised Algebraic Models*. Presses universitaires de Louvain. <https://books.google.cz/books?id=WKTK1n6ggKsC>
- C. Centazzo and E.M. Vitale. 2002. A duality relative to a limit doctrine. *Theory and Applications of Categories* 10 (2002), 486–497.
- E. Cheng. 2020. Distributive laws for Lawvere theories. *Compositionality* 2 (2020), 1.
- J.R.B. Cockett, X. Guo, and J.W. Hofstra, P. 2012. Range Categories II: towards regularity. *Theory and Applications of Categories* 26 (2012), 453–500.

- J.R.B. Cockett and P.J.W. Hofstra. 2008. Introduction to Turing Categories. *Annals of Pure and Applied Logic* 156 (2008), 183–209.
- J.R.B. Cockett and S. Lack. 2002. Restriction Categories I: categories of partial maps. *Theoretical Computer Science* 270 (2002), 223–259.
- J.R.B. Cockett and S. Lack. 2007. Restriction Categories III: colimits, partial limits, and extensivity. *Mathematical Structures in Computer Science* 17 (2007), 775–817.
- B. Coecke and R. Duncan. 2008. Interacting Quantum Observables. In *ICALP'08*. 298–310.
- P.L. Curien and A. Obtulowicz. 1989. Partiality, Cartesian Closedness, and Toposes. *Information and Computation* 80 (1989), 50–95.
- D. Dugger. 2001. Combinatorial model categories have presentations. *Advances in Mathematics* 164, 1 (2001), 177–201.
- T. Fox. 1976. Coalgebras and cartesian categories. *Communications in Algebra* 4 (1976), 665–667.
- P. Freyd. 1966. Algebra valued functors in general and tensor products in particular. In *Colloquium mathematicum*, Vol. 14. Institute of Mathematics Polish Academy of Sciences, 89–106.
- P. Freyd. 1972. Aspects of topoi. *Bulletin of the Australian Mathematical Society* 7, 1 (1972), 1–76.
- P.J. Freyd and A. Scedrov. 1990. *Categories, allegories*. North-Holland.
- P. Gabriel and F. Ulmer. 1971. *Lokal präsentierbare Kategorien*. Springer-Verlag, Berlin. v+200 pages.
- B. Giles. 2014. *An Investigation of some Theoretical Aspects of Reversible Computing*. Ph.D. Dissertation. The University of Calgary.
- M. Hyland and J. Power. 2007. The category theoretic understanding of universal algebra: Lawvere theories and monads. *Electronic Notes in Theoretical Computer Science* 172 (2007), 437–458.
- J. Kock. 2003. *Frobenius algebras and 2D topological quantum field theories*. Cambridge University Press.
- S. Lack. 2004. Composing PROPs. *Theory and Applications of Categories* 13, 9 (2004), 147–163.
- F.W. Lawvere. 1963. Functorial semantics of algebraic theories. *Proceedings of the National Academy of Sciences of the United States of America* 50, 5 (1963), 869.
- F.E.J. Linton. 1966. Some Aspects of Equational Categories. In *Proceedings of the Conference on Categorical Algebra*, S. Eilenberg, D. K. Harrison, S. MacLane, and H. Röhl (Eds.). Springer Berlin Heidelberg, Berlin, Heidelberg, 84–94.
- J.-L. Loday and B. Vallette. 2012. *Algebraic operads*. Grundlehren der Mathematischen Wissenschaften [Fundamental Principles of Mathematical Sciences], Vol. 346. Springer, Heidelberg. xxiv+634 pages. <https://doi.org/10.1007/978-3-642-30362-3>
- S. Mac Lane. 1965. Categorical algebra. *Bull. Amer. Math. Soc.* 71, 1 (1965), 40–106.
- M. Makkai and R. Paré. 1989. *Accessible categories: the foundations of categorical model theory*. Contemporary Mathematics, Vol. 104. American Mathematical Society, Providence, RI. viii+176 pages. <https://doi.org/10.1090/conm/104>
- M. Markl, S. Shnider, and J. Stasheff. 2002. *Operads in algebra, topology and physics*. Mathematical Surveys and Monographs, Vol. 96. American Mathematical Society, Providence, RI. x+349 pages.
- E. Palmgren. 2009. Constructivist and Structuralist Foundations: Bishop's and Lawvere's Theories of Sets.
- E. Palmgren and S.J. Vickers. 2007. Partial Horn logic and cartesian categories. *Annals of Pure and Applied Logic* 145 (2007), 314–353.
- D. Pavlovic. 2013. Monoidal Computer I: Basic Computability by String Diagrams. *Information and Computation* 226 (2013), 94–116.
- J. Power. 2006. Countable Lawvere theories and computational effects. *Electronic Notes in Theoretical Computer Science* 161 (2006), 59–71.
- E.P. Robinson and G. Rosolini. 1988. Categories of Partial Maps. *Information and Computation* 79 (1988), 94–130.
- R. Street. 1972. The formal theory of monads. *Journal of Pure and Applied Algebra* 2, 2 (1972), 149–168.